



HALFAR

BEST OF BAGS



HANDBOOK 2026



organic
cotton

MONO
JUST 1 MATERIAL
100% RECYCABLE

HALFAR® BAGS 2026



















BAGS THAT SURPRISE.

A laptop backpack with an insulated compartment for your lunchbox? A foldable rain cover that's always with you? A bag made from just one single material, from handle to lining, like our MONO? Or a collection of beautifully crafted organic cotton bags?

We've got them all! Because for us, it's all about making promotional bags even better – for YOU.

Be surprised by our new 2026 collection: from affordable entry-level models that make you want more to premium bags that impress with exclusive details. What always matters most: durability, functionality and design.

For love at first sight – and second. Enjoy discovering them!

			
Sustainability	Know-how	Design/range/service	25 good reasons
			
Waist bags	Leisure backpacks and drawstring bags	Backpacks for business	Sports backpacks and accessories
			
Bicycle bags	Shoulder bags	Laptop bags and organizers	Folders and covers
			
Sports and travel bags	Cosmetics and toilet bags	Shopping bags and baskets	Cooler bags
			
LorryBag® Modular bags	Decorations	Bag directory	

SUSTAINABILITY





RETHINK INSTEAD OF THROWING AWAY

We love moving forward - with ideas that inspire and solutions that last. For us, innovation means not only creating something new, but shaping the future. That's why at HALFAR® we are increasingly using recycled materials and continuously improving the recyclability of our new models – an important step towards a circular economy.

At the same time, we design bags made to last: high-quality, functional and perfect for everyday use. Because true sustainability starts where products are built to endure. And if something should ever need repair, our repair shop helps extend the life cycle of your favourite bag.

RELIABLE. RESPONSIBLE. COLOURFUL!



- ⊕ Management system
- ⊕ Corporate policy
- ⊕ Code of Conduct
- ⊕ Procurement policy
- ⊕ Environmental management system
- ⊕ Environmental policy
- ⊕ Climate strategy

HALFAR® stands for diversity – in our product range, our team and our thinking. Open, committed and responsible, we are dedicated to sustainable business practices, the climate and social issues. Whether as a training company, a family-friendly employer or through our diverse sustainability initiatives – we are engaged on many levels for a liveable future.

Read more:



amfori 
Trade with purpose

Member of amfori, the leading global business association for open and sustainable trade. We improve the social performance of our supply chain via amfori BSCI. For more information visit www.amfori.org

PSI
Academy
AWARDS
WINNER

Familien
Freundliches
Bielefeld



CSR-PREIS OWL
AUSGEZEICHNETES
UNTERNEHMEN 2022

EXCELLENT PRINTING AND SPEED

prosigno is part of the HALFAR® family. The screen-printing company, where people with and without disabilities work side by side, operates in the same building as we do. It belongs to Lebenshilfe Bielefeld, with whom we have been working successfully for over 20 years.

The prosigno team refines thousands of bags every year, achieving the highest print quality. prosigno prints almost exclusively with water-based and GOTS-certified ink systems as well as solvent-free digital printing inks – low in emissions and environmentally friendly for employees and users alike.

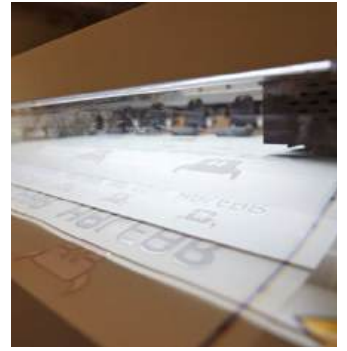
A digital prepress stage and a modern, well-equipped machinery park for screen and DTF printing ensure high flexibility and efficient processes. The short distances save resources, reduce emissions and ensure that the finished bags quickly reach their place of use.



CLIMATE-CONSCIOUS BY CONVICTION

Our enthusiasm for the environment and the climate is something you can actually see. If you've ever visited HALFAR® in Bielefeld, you may have noticed: the solar panels, the e-charging stations, the flowering meadows on the roof... and there's always something new being added.



- ⊕ Photovoltaics
- ⊕ Green electricity
- ⊕ Pellet heating
- ⊕ Green roofs and areas
- ⊕ E-charging stations
- ⊕ Heat pump



One thing is clear: as a company, we generate emissions – but wherever possible, we avoid and consistently reduce them. And where emissions are currently unavoidable, we take responsibility.



With a financial climate contribution, we support certified climate protection projects as a "ClimatePartner Certified Company".



ClimatePartner
 zertifiziertes Unternehmen
climate-id.com/G765H1



SPARING RESOURCES

Our logistics centre has been built according to the latest aspects of sustainability. It produces energy itself. We also actively save waste when it comes to packaging: Since 2023, we have stopped using many avoidable plastic bags. Read more about our measures here:



SAVING ENERGY

Whether photovoltaic system, wood pellet and insulation, green roof, LED lighting, green electricity: we pay attention to the economical use of energy and resources. We take a strategic approach through a process-controlled environmental management system and the ÖKOPROFIT® qualification programme.



STRENGTHENING BIODIVERSITY

Biodiversity is a matter close to our hearts. Whether for plants, bees or insects in general: we have created areas for them ranging from green roofs to natural meadowland – 1500 m² in our logistics centre alone. Together with Insect Respect®, we are active partners for projects in the region.



UNDERSTANDING THE STORY BEHIND AND THE DETAILS INSIDE

Good products are backed by good processes - and these are also important for climate and environmental protection.

That's why we arrange regular certification:



FROM EUROPE, FOR EUROPE

We love the European idea. We strive to strengthen development in Europe, secure jobs and foster both solidarity and an intercultural exchange. For us, cooperating with companies within the European Union that share these values is important to us, as is our belief in fair working conditions.



RELIABLY RECYCLED

We are always looking for alternatives that are even more sustainable, such as recycled materials like rPET. They help to save resources. We use the Global Recycled Standard (GRS) to which we have been certified since 2021.



"Halfar is GRS certified. Only the products which are covered by a valid transaction certificate are GRS certified."
certified by CU 1047624



SHAPING INTERNATIONAL COOPERATION



Member of amfori, the leading global business association for open and sustainable trade. We improve the social performance of our supply chain via amfori BSCL. For more information visit www.amfori.org

Our bags are manufactured in various locations in Europe and Asia. Wherever we work with people: We are fully committed to respecting human rights, maintaining occupational health and safety and

implementing all social standards of the International Labour Organization (ILO).

We have been a member of the amfori Business Social Compliance Initiative since 2009. It is a programme with the objective of improving social standards in a global value creation chain.



COTTON WITH SEAL OF APPROVAL

We use cotton that is certified in accordance with certain standards. The Standard 100 by OEKO-TEX® seal provides security for textiles that have been tested for harmful substances. The Fairtrade® Cotton seal distinguishes fairly grown and traded cotton. And last but not least, 100% of our organic cotton products are produced according to GOTS.



GOTS SUPPLY CHAINS

The Global Organic Textile Standard (GOTS) is the world leader in the processing of textiles made from organically produced natural fibres. It defines all environmental requirements along the entire textile production chain as well as the social criteria for the companies. HALFAR® itself is also GOTS-audited as a business.



Certified by CU 1047624

MAKING GOOD EVEN BETTER











Smarter. More practical. More colourful. More compact. More resource-saving. More durable...

We never run out of ideas for making bags even better. This has already earned us several awards – and even more hearts.

Most recently, for example, with the Shopper MONO – our first product made entirely from a single material, perfectly designed for the circular economy.

10

DESIGN PRIZES

-  Promotional Gift Award 2023
-  Promotional Gift Award 2022
-  Promotional Gift Award 2021
-  Promotional Gift Award 2020
-  Promotional Gift Award 2019
-  Promotional Gift Award 2017
-  Promotional Gift Award 2011
-  Promotional Gift Award 2007
-  Promotional Gift Award 2006
-  Promotional Gift Award 2005



GOOD FOR THE CIRCULAR FLOW

With MONO, we're taking sustainability a step further – by reducing material use to the minimum. MONO bags are made entirely from a single material, through and through. Pure in composition and therefore fully recyclable.



UPCYCLING: CREATIVITY INSTEAD OF WASTE

Some materials are simply too good to throw away. Patterned office curtains, for example. Printed textile banners from the last trade fair. The leather from legendary aircraft seats. Or the tarpaulin of a truck.

Through our upcycling concept, you can turn them into something better: a unique bag collection – provided, of course, that the materials can be sewn and meet the conditions for meaningful reuse.



Find out more about the HALFAR modular system and custom-made designs on page 208.

What actually happens to a truck tarpaulin once it's no longer in use? At HALFAR®, we turn it into bags – for example, this custom-made courier backpack.



FABULOUS FEATURES

Commuting, working remotely – all that makes you hungry. That's why, in this new laptop backpack, we've created a special protected space not only for your tech, but also for your snack. An insulated compartment ensures everything stays fresh.

REPAIR? WE CAN.

HALFAR® is a bag maker. This means that we have been manufacturing our bags ourselves for over 30 years, some of them directly in Bielefeld in our own sewing shop. We have the experts in-house. Our repair service means that they are also here to help after the purchase of a bag. They can give advice, take care of spare parts, modify, repair or exchange. In this way we conserve resources, avoid waste, ensure greater sustainability and, above all, ensure that favourite bags remain favourite bags for a long time to come.



LONGLASTING AND GOOD

We pay attention to safe components and the professional finishing of our bags. Design quality is also important to us. Because what is well done and looks good will be used for longer and does less damage to the environment - that is sustainability as we understand it.



FULL OF DRIVE. FULL OF IQ.

**WITH OUR SERVICES, YOUR
PERFECT BAG IS JUST A SMART
STEP AWAY.**



„The right bag, at the right time, in the right place: that's what we roll up our sleeves for here in warehousing and logistics. Our customers appreciate that.“

OUR WARE- HOUSE:

- › on-time delivery, also internationally
- › more than 10,000 pallet spaces, more than 5 million products
- › planned delivery, in line with your delivery forecast
- › picking, packing and delivery as required
- › consignment warehouse and security warehouse possible



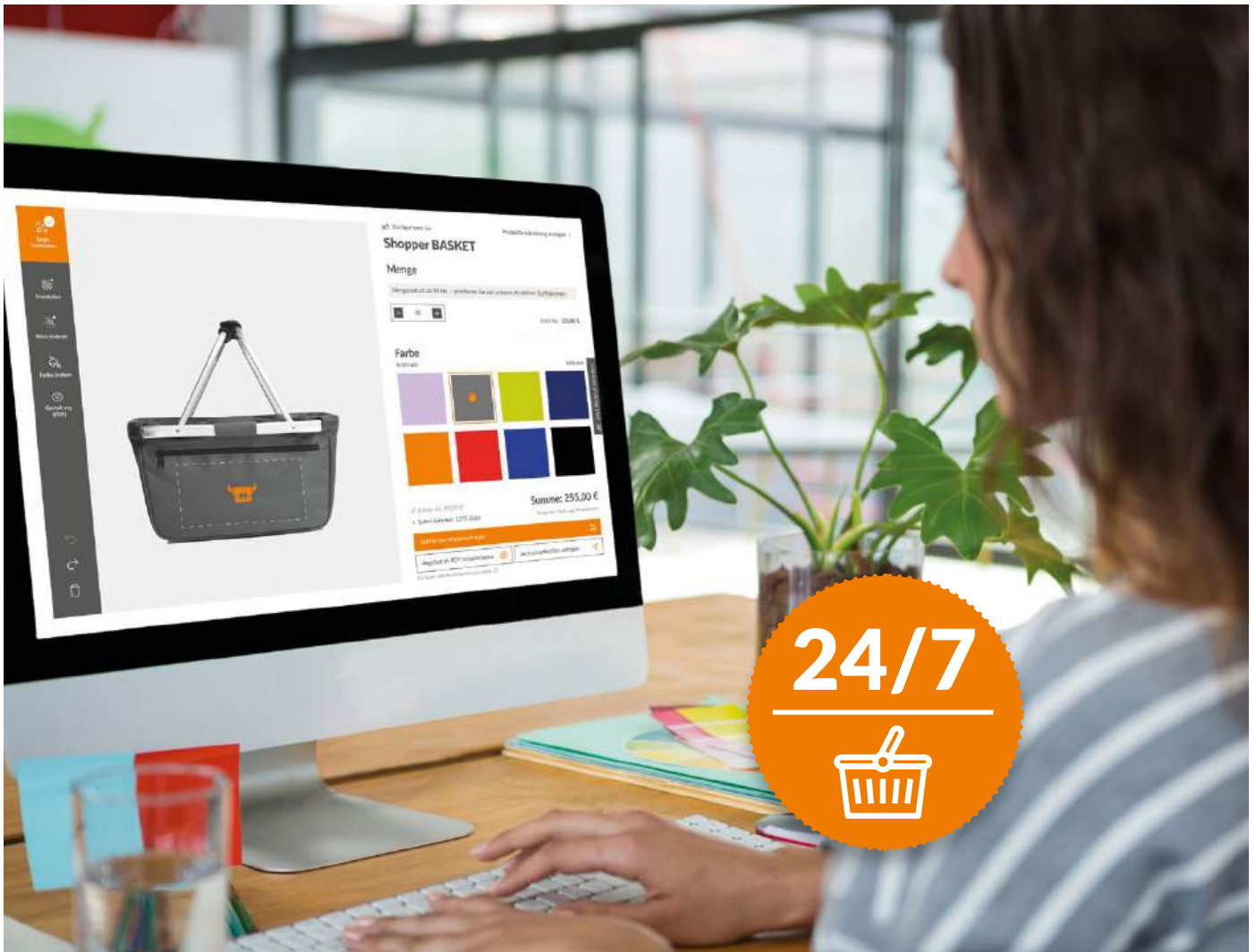

NEW: THE BAG LOGO PRICE CONFIGURATOR

Now easier than ever: simply choose a bag, place your branding online, and get your price. Our new online configurator makes it all possible – anytime, 24 hours a day, seven days a week. With super simple ALL-IN-ONE branding prices – transparent, easy to understand and instantly calculable.

Create quotes for your customers even faster and more flexibly – and visualise the perfect branding straight away. Learn more about branding options on page 214.

REALLY FAST: HALFAR® FAST LANE

It's one of the fastest finishing methods – and at the same time particularly high-quality and sustainable. After all, HALFAR FAST LANE® delivers photo-quality printing.

The process uses solvent-free inks, ensures highly energy-efficient drying, and relies on our photovoltaic and green power systems.

Example:
HALFAR FAST LANE®

 PROMOTIONAL GIFT
AWARD 2020



25

good reasons



Recycled material

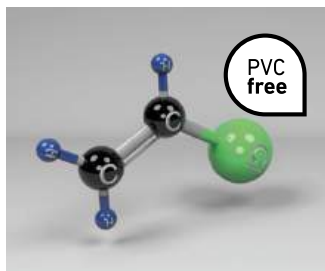

PVC free



Cotton



Organic cotton



Jute cotton



Cabin size (IATA compliant)



Filling quantity



Suitable for contact with food



Temperature retaining

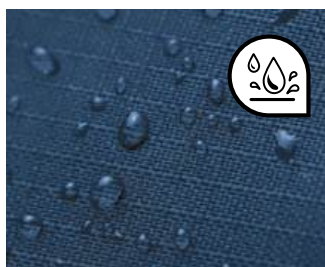

Resistant to splashes



Halfar Fast Lane® finishing



Anti-theft functions



RFID shield



Folding



Airtag compartment



Suitable for 15" laptops



Suitable for most tablets



Lightweight



Headphone socket



Shoe compartment



Backpack carrying function



Organiser



Part of a bag family

HALFAR[®] BAGS



WAIST BAGS





yellow (4)



1818058 PURE
WAIST BAG

trendy hip bag; main compartment with 2-way zipper and flat inner pocket; water-repellent zippers; front pocket with zipper; adjustable strap with elastic flap to secure the strap; can be worn as a hip or body bag; large side buckle for easy opening and closing

Material: rPET soft PU
 Size (cm): W 26 x H 17 x D 9
 Packing (pcs): 20
 Decoration area (cm, silkscreen): on front pocket W 15 x H 6
 Decoration possibilities: silkscreen print; embroidery; transfer print; metal emblem; digitally printed label; doming





navy (3)



navy (3)



black (1)

navy (3)

red (5)

white (18)

apple green (187)

cyan (652)



1813352 **STEP** WAIST BAG

main compartment with 2-way zipper and inner zip compartment; front zip pocket; rear-side comfortable padding; front reflector stripes; length-adjustable and side-closing waist strap

Material: Polyester 420d & ripstop

Size (cm): W 24 x H 14 x D 7

Packing (pcs): 50

Decoration area (cm, silkscreen): on front pocket W 17 x H 5

Decoration possibilities: silkscreen print; embroidery; doming; digitally printed label; transfer print; metal emblem



black (1)

navy (3)

red (5)



1809793 **SOLUTION** WAIST BAG

zipper main compartment and front pouch with 2-way zipper; comfortable padded back; adjustable waist belt

Material: Polyester 600d

Size (cm): W 30 x H 16 x D 7

Packing (pcs): 50

Decoration area (cm, silkscreen): on front pocket W 11 x H 6

Decoration possibilities: silkscreen print; transfer print; embroidery; doming; digitally printed label; metal emblem



navy (3)

zipped pocket
on back



black (1)



navy (3)



red (5)



anthracite (10)



green (223)



1818022 **DAILY** WAIST BAG

lightweight sling bag; rPET upper material; zipped main compartment; zipped compartment on the back; length-adjustable, side-closing waist strap with elastic tab

Material: rPET 600d

Size (cm): W 29 x H 12 x D 8

Packing (pcs): 100

Decoration area (cm, silkscreen): on the front W 16 x H 3

Decoration possibilities: silkscreen print; embroidery; transfer print; digitally printed label; metal emblem



LEISURE BACKPACKS AND DRAWSTRING BAGS





new



copper (645)



1818064 **BASIC**
BACKPACK

practical roll top rucksack; recycled outer material; large main compartment with zipper and additional press stud; attractive reflective print; rPET outer material; large padded pocket; airbag pocket; large front pocket with zipper; two side pockets, e.g. for a water bottle, padded carrying system, handle

Material: rPET 300d
 Size (cm): W 29 x H 44 x D 14
 Packing (pcs): 25
 Decoration area (cm, silkscreen): on front pocket W 14 x H 16
 Decoration possibilities: silkscreen print; embroidery; transfer print; metal emblem; digitally printed label; doming



black (1) navy (3) red (5) beige (198)





apple green (187)



apple green (187)

royal blue (8)

yellow (4)

white (18)



1815024 FLOW BACKPACK

sporty, light-weight backpack with front zipper pocket; zipper main compartment; padded back and shoulder straps; carrying handle

Material: Polyester 600d

Size (cm): W 22 x H 40 x D 11

Packing (pcs): 50

Decoration area (cm, silkscreen): on front pocket W 8 x H 17

Decoration possibilities: silkscreen print; embroidery; doming; metal emblem; transfer print; digitally printed label





red (5)



apple green (187)



green (171)

black (1)

fuchsia (307)

white (18)

orange (169)

red (5)



navy (3)

light blue (170)

apple green (187)

pink (172)

red (5)

orange (169)



1813355 SOLUTION BACKPACK

modern backpack with zipper front pocket; main compartment with 2-way zipper and flat inside compartment; rain flap; front reflector stripes, padded back and shoulder straps; handle

Material: Polyester 600d
Size (cm): W 28 x H 43 x D 11
Packing (pcs): 25

Decoration area (cm, silkscreen): on the front W 13 x H 16
Decoration possibilities: silkscreen print; embroidery; transfer print; doming; digitally printed label; metal emblem



1802722 KIDS BACKPACK

zipper main compartment and front pocket; padded adjustable shoulder straps

Material: Polyester 600d
Size (cm): W 25 x H 30 x D 10/13
Packing (pcs): 50

Decoration area (cm, silkscreen): on front pocket W 10 x H 8;
above front pocket W 10 x H 6
Decoration possibilities: silkscreen print; transfer print; embroidery; digitally printed label; metal emblem; doming



light blue (170)



1802716 **SPORT** TAFFETA BACKPACK

backpack with cord straps

Material: Polyester 210d

Size (cm): W 33 x H 42

Packing (pcs): 100

Decoration area (cm, silkscreen): on the front W 23 x H 30

Decoration possibilities: silkscreen print; transfer print



green (171)



apple green-green (727)

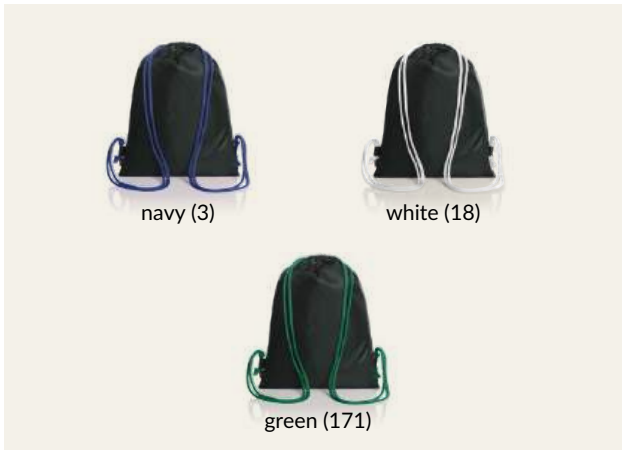

navy (3)

white (18)

green (171)



red-yellow (724)

apple green-green (727)

navy-red (726)



1813051 FLASH
DRAWSTRING BAG

backpack with coloured cord straps

Material: Polyester 210d
Size (cm): W 33 x H 42
Packing (pcs): 100
Decoration area (cm, silkscreen): on the front W 23 x H 30
Decoration possibilities: silkscreen print; transfer print



1813060 PAINT
DRAWSTRING BAG

backpack with coloured cord straps

Material: Polyester 210d
Size (cm): W 33 x H 42
Packing (pcs): 100
Decoration area (cm, silkscreen): on the front W 23 x H 30
Decoration possibilities: silkscreen print; transfer print



green (55)

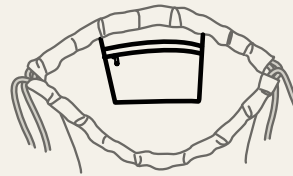

hidden zipper pocket



1816079 CARE DRAWSTRING BAG

functional drawstring backpack; rPET upper material; main compartment with drawstring; zipped inside pocket; extra-thick cord

Material: rPET 300d

Size (cm): W 36 x H 44

Packing (pcs): 50

Decoration area (cm, silkscreen): on the front W 28 x H 33

Decoration possibilities: silkscreen print; embroidery; transfer print; digitally printed label; metal emblem



black (1)



anthracite (10)



white (18)



navy (3)



red (5)



green (55)



white (18)

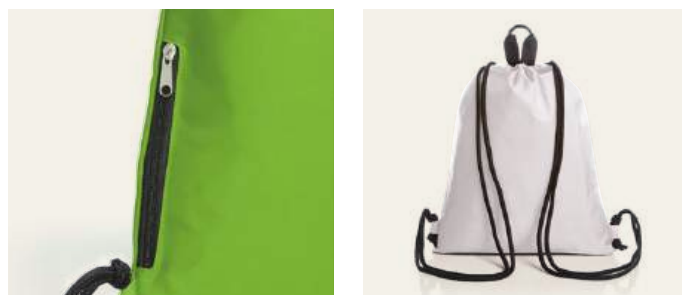

1813055 JOIN
DRAWSTRING BAG

large drawstring backpack; main compartment with lateral zipper pocket; drawstring; carrying loop

Material: rPET Mini ripstop

Size (cm): W 36 x H 45

Packing (pcs): 100

Decoration area (cm, silkscreen): on the front W 23 x H 34

Decoration possibilities: silkscreen print; transfer print; embroidery; digitally printed label; doming; metal emblem





anthracite (10)



red (5)



anthracite (10)



apple green (187)

black (1)

navy (3)

red (5)



1814002 JERSEY DRAWSTRING BAG

large drawstring bag made from fine jersey material which is pleasant to the touch; main compartment with side zipper bag; pull cord; carry loop

Material: Polyester Jersey

Size (cm): W 36 x H 45

Packing (pcs): 50

Decoration area (cm, silkscreen): on the front W 23 x H 30

Decoration possibilities: silkscreen print; transfer print; doming



1813349 STEP DRAWSTRING BAG

large drawstring bag; main compartment with side zipper pocket; reflector stripes; pull cord; carry loop

Material: Polyester 300d & ripstop

Size (cm): W 36 x H 45

Packing (pcs): 50

Decoration area (cm, silkscreen): on the front W 23 x H 27

Decoration possibilities: silkscreen print; embroidery; transfer print; doming; digitally printed label



light grey (145)



1815000 DIAMOND BACKPACK

lightweight, innovative backpack with diamond pattern; reversible; zippered main compartment, with additional winding function; side zipper pocket; woven, length-adjustable shoulder straps

Material: Polyester 600d

Size (cm): W 35 x H 50

Packing (pcs): 50

Decoration area (cm, silkscreen): on the front W 23 x H 33

Decoration possibilities: silkscreen print; embroidery; doming; metal emblem; transfer print; digitally printed label



red (5)

blue (155)

black (1)

light grey (145)

multicolored (95)



apple green (187)



black (1)

red (5)

white (18)

apple green (187)

navy (3)



1813057 EARTH DRAWSTRING BAG

cotton drawstring bag; backpack with cord straps

Material: cotton 5 OZ (~142 g/m²)

Size (cm): W 38 x H 45

Packing (pcs): 100

Decoration area (cm, silkscreen Basic): on the front W 23 x H 34

Decoration possibilities: silkscreen Basic print; transfer print; embroidery; digitally printed label



nature (704)



1813052 ORGANIC DRAWSTRING BAG

organic cotton drawstring backpack

Material: organic cotton 6 OZ (~170 g/m²)

Size (cm): W 38 x H 45

Packing (pcs): 100

Decoration area (cm, silkscreen Basic): on the front W 23 x H 34

Decoration possibilities: silkscreen Basic print; transfer print; embroidery; digitally printed label



blue (155)



beige (22)

blue (155)

light grey (145)

red (215)



1816063 PLANET DRAWSTRING BAG

lightweight drawstring bag made from pre-recycled cotton; main compartment with drawstring

Material: pre-recycled cotton 5 OZ (~142 g/m²)

Size (cm): W 38 x H 42

Packing (pcs): 100

Decoration area (cm, silkscreen Basic): on the front W 28 x H 31

Decoration possibilities: silkscreen Basic print; embroidery; transfer print; digitally printed label



red (5)



1816505 **LIKE** BACKPACK

urban backpack with high-quality metal accessories; main compartment with 2-way zipper; flat insert pocket inside; front pocket with hook & loop tape fastener; handles with press stud; adjustable cotton shoulder straps

Material: cotton 12 OZ (~340 g/m²)

Size (cm): W 27 x H 38 x D 13

Packing (pcs): 25

Decoration area (cm, silkscreen): on front pocket W 17 x H 4,5;
on the front W 21 x H 7

Decoration possibilities: silkscreen print; embroidery; metal emblem; transfer print; digitally printed label



navy (3)

red (5)

black (1)

nature (704)

olive (56)



navy (3)



1813348 BEACH BACKPACK

young backpack with freshly block stripe decoration; generous cut with straight back; large front pocket with hook and loop tape closure; decorative eyelets and thick cotton cord straps

Material: cotton 11 OZ (~312 g/m²)

Size (cm): W 30 x H 48 x D 15

Packing (pcs): 25

Decoration area (cm, silkscreen): on front pocket W 17 x H 13

Decoration possibilities: silkscreen print; embroidery; metal emblem; transfer print; digitally printed label



navy (3)

orange (169)

anthracite (10)

apple green (187)



neon yellow (32)



1812204 REFLEX DRAWSTRING BAG

main compartment with drawstring; bright neon yellow body fabric with 3M™ Scotchlite™ reflective stripes

Material: Polyester 900d

Size (cm): W 33 x H 43

Packing (pcs): 100

Decoration area (cm, silkscreen): on the front W 23 x H 23

Decoration possibilities: silkscreen print; transfer print; embroidery; digitally printed label



neon yellow (32)



1812206 REFLEX BACKPACK

large main compartment with 2-way zipper and rain flap; interior mesh pocket, padded pouch; headphone output; front pocket with 2-way zipper, rain flap and organizer; handle; padded back and shoulder straps; height-adjustable chest strap; bright neon yellow body fabric with 3M™ Scotchlite™ reflective stripes

Material: Polyester 900d

Size (cm): W 27 x H 42 x D 15

Packing (pcs): 10

Decoration area (cm, silkscreen): on front pocket W 20 x H 10

Decoration possibilities: silkscreen print; transfer print; embroidery; digitally printed label; metal emblem



blue (155)



blue (155)

black (1)

navy (3)

yellow (4)



1818036 FELLOW NOTEBOOK BACKPACK

spacious main compartment with 2-way zip; padded notebook compartment; two zipped front pockets; two side slip-in pockets; back and shoulder straps padded with height-adjustable chest belt; handle

Material: rPET 600d

Size (cm): W 28 x H 42 x D 12

Packing (pcs): 20

Decoration area (cm, silkscreen): on upper front pocket W 17 x H 7, on lower front pocket W 17 x H 18

Decoration possibilities: silkscreen print; embroidery; transfer print; digitally printed label; metal emblem



dusky pink (450)

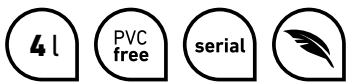

1816080 TREND MONOSTRAP

modern single-strap backpack; main compartment with two-way zip; flat pouch inside; zipped compartment on back; padded, adjustable shoulder strap can be worn on either side; carrying loop

Material: Polyester 600d
Size (cm): W 18 x H 30 x D 8
Packing (pcs): 50

Decoration area (cm, silkscreen): on the front W 12 x H 17
Decoration possibilities: silkscreen print; embroidery; transfer print; doming; digitally printed label; metal emblem



1818061 STAR

upholstered
notebook
compartment

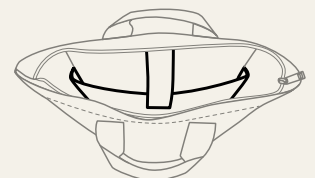



ice blue (225)



dusky pink (450)



1818061 **STAR** LAPTOP BACKPACK

fashionable roll-top backpack; zippered main compartment with adjustable fastening system; loop strap on the lid; high-quality metal accessories; padded notebook compartment; zippered front pocket; two side pockets; padded base; padded carrying system; fastening loop on the back for trolley handle; handle

Material: Polyester 290d Twill
Size (cm): W 28 x H 43 x D 16
Packing (pcs): 20

Decoration area (cm, silkscreen): on front pocket W 16 x H 20
Decoration possibilities: silkscreen print; embroidery; transfer print; metal emblem; digitally printed label; doming



1818062 **STAR S** BACKPACK

fashionable roll-top backpack; zippered main compartment with adjustable fastening system; loop strap on the lid; high-quality metal accessories; padded device compartment; zippered front pocket; two side pockets; padded base; padded carrying system; fastening loop on the back for trolley handle; handle

Material: Polyester 290d Twill
Size (cm): W 25 x H 34 x D 14,5
Packing (pcs): 20

Decoration area (cm, silkscreen): on front pocket W 14 x H 16
Decoration possibilities: silkscreen print; embroidery; transfer print; metal emblem; digitally printed label; doming



green (55)

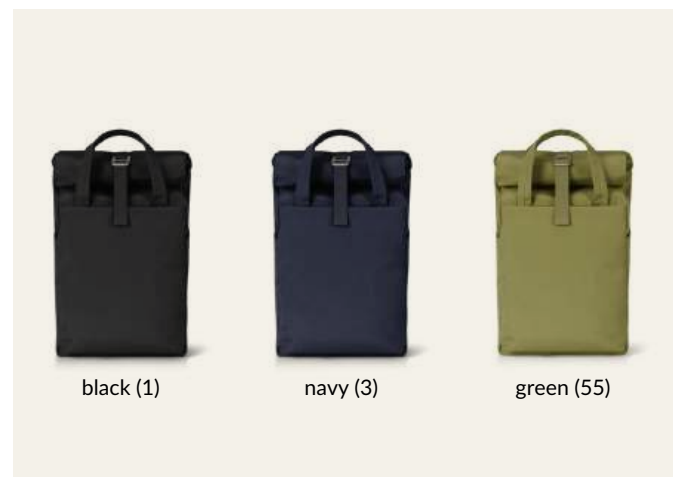

black (1)

navy (3)

green (55)



1819202 METRO BACKPACK

attractive leisure backpack with roll-up closure, premium metal buckle and sewn handles; volume expansion; main compartment with padded equipment compartment; large zipped front pocket; two side slip-in pockets; large zipped side compartment on the back; well-padded carrying system

Material: Polyester 600d

Size (cm): W 27 x H 37/49 x D 15

Packing (pcs): 20

Decoration area (cm, silkscreen print): on front pocket

W 17 x H 16

Decoration possibilities: silkscreen print; embroidery; transfer print; digitally printed label; metal emblem



navy (3)



1818038 EVENT
MULTI BAG

versatile, functional companion with a large promotional space; main compartment with concealed zip, fits A4 documents; length-adjustable strap system, can be worn as a shoulder bag or backpack; handle

Material: rPET
Size (cm): W 28 x H 35 x D 5
Packing (pcs): 50
Decoration area (cm, silkscreen): on the front W 15 x H 22
Decoration possibilities: silkscreen print; embroidery; transfer print; digitally printed label; metal emblem



backpack function



jade green (19)

beige (198)

dark burgundy (745)

black (1)

navy (3)

anthracite (10)



black (1)



1813058 **URBAN** NOTEBOOK BACKPACK

young notebook backpack with trendy, geometric cut; combination of melange fabric and artificial velour leather; main compartment with padded notebook compartment; zipper front pouch with two flat insert pockets; two-way zippers; padded back and shoulder straps

Material: Polyester 300d sprinkle & velour imitation leather

Size (cm): W 32 x H 41 x D 15

Packing (pcs): 10

Decoration area (cm, silkscreen): on front pocket W 24 x H 14

Decoration possibilities: silkscreen print; embroidery; transfer print; digitally printed label; metal emblem



brown (735)



grey (54)



black (1)



anthracite (10)



1818056 MODERNCLASSIC BACKPACK

backpack made of fine felt; recycled outer material; adjustable closure with loop strap and metal buckles; padded equipment compartment; padded carrying system with adjustable shoulder straps; concealed zippered pocket on back; handle

Material: recycled PES felt
 Size (cm): W 35,5 x H 42 x D 8
 Packing (pcs): 25
 Decoration area (cm, embroidery): on the front W 14 x H 14
 Decoration possibilities: embroidery; transfer print; metal emblem; digitally printed label





green (223)



red (5)



black (1)

green (223)

navy (3)

red (5)

anthracite (10)



1818016 DAILY NOTEBOOK BACKPACK

charming rectangular-shaped backpack; rPET upper material; spacious main compartment with 2-way zip; padded notebook compartment; flat slip-in compartment inside; side snap buckles for convenient opening; snap buckles can be connected to make a handle; large zipped front pocket; two side slip-in compartments e.g. for water bottles; padded carrying system; handles with press stud cuff

Material: rPET 600d
Size (cm): W 30 x H 42 x D 12
Packing (pcs): 20
Decoration area (cm, silkscreen): on front pocket W 22 x H 20
Decoration possibilities: silkscreen print; transfer print; embroidery; digitally printed label; metal emblem



black (1)

red (5)

navy (3)

anthracite (10)

green (223)



1818014 DAILY LAPTOP BACKPACK

urban flap backpack; large main compartment with zip and additional hook-and-loop flap; rPET upper material; padded notebook compartment and flat slip-in compartment inside; large front zip pocket; two side slip-in compartments e.g. for water bottles; padded carrying system; handle

Material: rPET 600d
Size (cm): W 28 x H 42 x D 13
Packing (pcs): 20
Decoration area (cm, silkscreen): on front pocket W 19 x H 18
Decoration possibilities: silkscreen print; embroidery; transfer print; digitally printed label; metal emblem



green grey (644)



separate notebook compartment with velour lining



hidden pocket for smartphone, keys, etc.



comfortably padded back and carrying system



volume expansion to 22L



1818048 FLEX NOTEBOOK BACKPACK

versatile backpack with innovative volume expansion; rPET upper material; spacious main compartment with zip; flat slip-in pocket inside; large zipped front pocket; functional loop strap with elasticated cord; two side slip-in pockets for drink bottles, for example; fixing straps; separately accessible notebook compartment with velour lining on the back; padded carrying system; concealed zipped pocket on the back; padded base; handles on the back also for use as a fastening loop for trolley bars; carrying handle

Material: rPET 600d
 Size (cm): W 29 x H 48/64 x D 12
 Packing (pcs): 10
 Decoration area (cm, silkscreen print): on front pocket W 15 x H 12
 Decoration possibilities: silkscreen print; embroidery; transfer print; digitally printed label; metal emblem





beige (198)



1819201 MELLOW BACKPACK

urban backpack with zipped main compartment and buckle fastening; rPET upper material; padded pocket and organizer elements inside; zipped outer pocket on side; two side pouches for bottles etc.; zipped pocket on back; padded strap system; handle

Material: rPET 300d

Size (cm): W 27 x H 47/56 x D 12

Packing (pcs): 25

Decoration area (cm, silkscreen): on front pocket W 12 x H 20

Decoration possibilities: silkscreen print; embroidery; transfer print; digitally printed label; metal emblem



taupe (220)



1816089 STAGE NOTEBOOK BACKPACK

modern backpack with contrasting stripes; HFL® carrier for your logo; large main compartment with 2-way zip; padded notebook compartment; pockets; pen loops; large front pocket with zip, padded back and shoulder straps; handles with press stud cuff

Material: Polyester 500d

Size (cm): W 32 x H 43 x D 14

Packing (pcs): 20

Decoration area (cm, HFL® sticker): on HFL® carrier

W 5,7 x H 2,3

Decoration possibilities: HALFAR FAST LANE®; silkscreen print; embroidery; transfer print; digitally printed label; doming



RECYCLED
PET 



yellow (4)



black (1)



navy (3)



yellow (4)



beige (198)



olive (56)



1818059 PURE LAPTOP BACKPACK

elegant, urban backpack; main compartment with reinforced base; water-repellent zippers, padded notebook compartment with rubber tab; flat zippered compartment; zipped front pocket; padded carrying system; handle

Material: rPET soft PU

Size (cm): W 28 x H 43 x D 13

Packing (pcs): 10

Decoration area (cm, silkscreen): on front pocket W 16 x H 16

Decoration possibilities: silkscreen print; embroidery; transfer print; metal emblem; digitally printed label; doming





black (1)



blue-grey sprinkle (722)

upholstered
notebook compartment

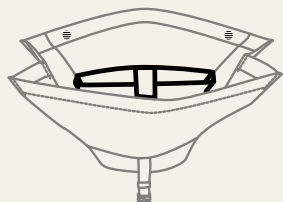

upholstered
notebook compartment

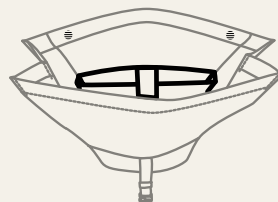

1815012 LOFT NOTEBOOK BACKPACK

fashionable notebook backpack with striking buckle closure; main compartment with zip and zip protection; padded on the side and back; notebook compartment; two flat inner pockets; flat, large inner zip pocket; outside side zip pocket; elaborately-stitched back; length-adjustable, padded shoulder straps with height- and width-adjustable chest strap; hand grip

Material: Polyester 600d
Size (cm): W 34 x H 45/59 x D 13
Packing (pcs): 20

Decoration area (cm, silkscreen): on the front W 23 x H 24
Decoration possibilities: silkscreen print; embroidery; transfer print; digitally printed label; metal emblem



1812198 FASHION NOTEBOOK BACKPACK

rollover backpack with an innovative closing system; large main compartment with hanging zipper pocket; padded notebook compartment; two zippered front pockets; padded back and straps; handle

Material: Polyester 300d sprinkle
Size (cm): W 30 x H 44/53 x D 14
Packing (pcs): 20
Decoration area (cm, silkscreen): on front pocket W 10 x H 10
Decoration possibilities: silkscreen print; transfer print; embroidery; digitally printed label; metal emblem



black (1)



black (1)



1803908 KURIER ECONOMY BACKPACK

zipper front pocket; padded back with zipper compartment;
padded shoulder straps; waist and breast strap

Material: tarpaulin

Size (cm): W 34 x H 62/48 x D 14,5

Packing (pcs): 10

Decoration area (cm, silkscreen): on front pocket W 18 x H 20

Decoration possibilities: silkscreen print; embroidery; digitally
printed label; metal emblem; doming



anthracite (10)



1816072 COUNTRY BACKPACK

large, zipped main compartment, padded front and back; two flat pouches inside; padded base; innovative zipped front pocket for one or two-sided opening; handle; padded, adjustable shoulder straps; high-quality metal accessories and PU velour artificial leather applications

Material: cotton 16 OZ (~453 g/m²)

Size (cm): W 31 x H 40/50 x D 10

Packing (pcs): 25

Decoration area (cm, silkscreen): on the front W 13 x H 20

Decoration possibilities: silkscreen print; embroidery; transfer print; digitally printed label; metal emblem

innovative zipper
front pocket

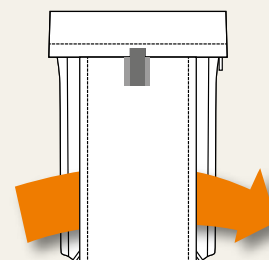

navy (3)



anthracite (10)



navy (3)

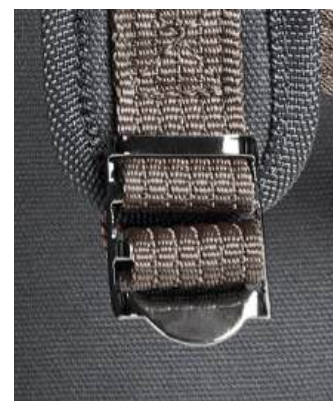

1816502 COUNTRY NOTEBOOK BACKPACK

flap with adjustable decorative buckles and magnetic clasp; large main compartment with drawstring fastener; padded notebook compartment; front pocket with 2-way zipper; two flat insert pockets; handle with grip cuff; padded, adjustable shoulder straps; high-quality metal and PU suede faux leather accessories

Material: cotton 16 OZ (~453 g/m²)

Size (cm): W 31 x H 46 x D 14

Packing (pcs): 20

Decoration area (cm, silkscreen): on front pocket W 17 x H 17

Decoration possibilities: silkscreen print; embroidery; transfer print; digitally printed label; metal emblem



navy (3)

khaki (739)

anthracite (10)

RECYCLED
PET 



black sprinkle (678)



nature (704)

light-grey sprinkle
(728)green sprinkle
(717)blue-grey sprinkle
(722)black sprinkle
(678)

grey (54)

nature (704)



1816076 CIRCLE NOTEBOOK BACKPACK

urban backpack with zipped main compartment and buckle fastening; rPET upper material; padded pocket and organizer elements inside; zipped outer pocket on side; two side pouches for bottles etc.; zipped pocket on back; padded strap system; handle

Material: rPET 300d

Size (cm): W 27 x H 47/56 x D 12

Packing (pcs): 25

Decoration area (cm, silkscreen): on front pocket W 15 x H 18

Decoration possibilities: silkscreen print; embroidery; transfer print; digitally printed label; metal emblem



1816068 LOOM BACKPACK

large zipped main compartment with addition roll fastening; large flat pouch; zipped inside pocket; elaborately quilted and padded back; padded base; zipped pocket on back; padded, adjustable shoulder straps; high-quality metal accessories

Material: cotton/Polyester

Size (cm): W 28 x H 43 x D 14

Packing (pcs): 20

Decoration area (cm, silkscreen): on the front W 26 x H 33

Decoration possibilities: silkscreen print; embroidery; transfer print; digitally printed label; metal emblem



grey-brown (309)

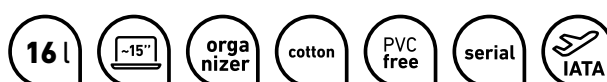

1816520 LIFE NOTEBOOK BACKPACK

modern, elaborately crafted flap backpack; lovingly designed with high-quality metal accessories and coated cotton trims; flap fastened in place with integrated magnetic clasp; large zipper main compartment; zipper inner pocket; padded notebook compartment; two flat insert pockets; secure zipper rear insert pocket; handles with press stud; padded, adjustable shoulder straps with elastic fixing for waist strap

Material: cotton 12 OZ (~340 g/m²)

Size (cm): W 28 x H 42 x D 14

Packing (pcs): 25

Decoration area (cm, silkscreen): on the front W 20 x H 11

Decoration possibilities: silkscreen print; embroidery; transfer print; digitally printed label; metal emblem

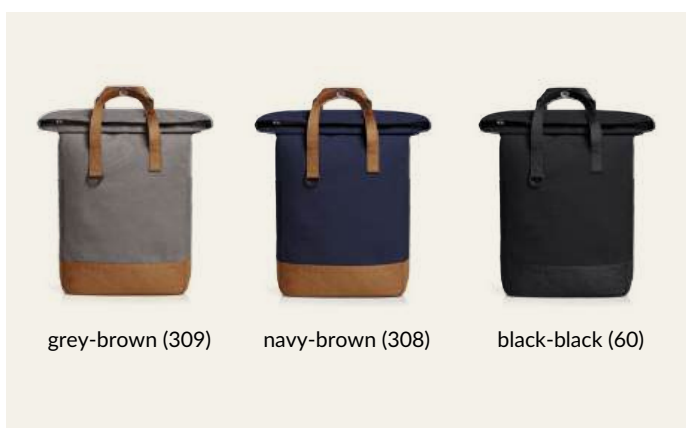

grey-brown (309)

navy-brown (308)

black-black (60)

HALFAR
FAST
LANE®
////////



black (1)

LED bicycle light
attachment option



1818039 REFLEX M LAPTOP BACKPACK

stylish, reflective roll-top backpack with zipped main compartment and buckle; HFL® straps for your logo; padded slip-in pocket and zipped mesh pocket inside; two side slip-in pockets; zipped front pocket; LED bicycle light attachment option; padded carrying system with height-adjustable chest strap; handle

Material: Polyester 600d

Size (cm): W 26 x H 39 x D 16

Packing (pcs): 10

Decoration area (cm, HFL® sticker): on HFL® carrier W 5,7 x H 2,3

Decoration possibilities: HALFAR FAST LANE®, silkscreen print; embroidery; transfer print; doming





HALFAR
FAST
LANE®

Rooster

black (1)



RECYCLED
PET

light-grey sprinkle (728)



upholstered
notebook
compartment



LED bicycle
light
attachment option



light-grey sprinkle
(728)

black sprinkle
(678)

green sprinkle
(717)

blue-grey sprinkle
(722)



1818018 REFLEX L NOTEBOOK BACKPACK

stylish, reflective roll-top backpack with zipped main compartment and buckle; HFL® straps for your logo; padded slip-in pocket and zipped mesh pocket inside; two side slip-in pockets; fixing straps; zipped front pocket; LED bicycle light attachment option; rear attachment loop for trolley handle; concealed zipped pocket; padded carrying system with height-adjustable chest strap; handle

Material: Polyester 600d
Size (cm): W 30 x H 44 x D 18
Packing (pcs): 10
Decoration area (cm, HFL® sticker): on HFL® carrier W 5,7 x H 2,3
Decoration possibilities: HALFAR FAST LANE®, silkscreen print; embroidery; transfer print



1818032 CIRCLE L NOTEBOOK BACKPACK

urban backpack with zipped main compartment and buckle; rPET upper material; padded slip-in pocket and organiser elements inside; side zipped front pocket; two side slip-in pockets; fixing straps; rear zipped pocket; padded carrying system with height-adjustable chest strap; handle

Material: rPET 300d
Size (cm): W 30 x H 47/64 x D 16
Packing (pcs): 25
Decoration area (cm, silkscreen): on the front pocket W 19 x H 17
Decoration possibilities: silkscreen print; embroidery; transfer print; digitally printed label; metal emblem

new



olive (56)



1818057 MOLLE NOTEBOOK BACKPACK

functional backpack with 3-sided Molle strap system and Velcro trim; elastic cord trim; large main compartment with concealed 2-way zip; padded notebook compartment with Velcro flap; port for cable or drinking tube; large mesh pocket with zipper; front pocket with 2-way zipper and organiser compartments; side compression straps with buckles, can also be closed at the front and back, e.g. for trolley handle attachment; D-rings on the right and left; padded back carrying system with height-adjustable chest strap; D-rings and detachable elastic loops on the straps, length-adjustable waist strap; handle

Material: Polyester 600d

Size (cm): W 28 x H 46 x D 14

Packing (pcs.): 10

Print area (cm, silkscreen) on front pocket W 16 x H 8

Decoration possibilities: silkscreen print; embroidery; transfer print; digitally printed label; metal emblem; doming



olive (56)

coyote brown (310)

black (1)



red (5)



- 26 l
- anti theft
- serial
- PVC free

1814021 **STORM** BACKPACK

spacious main zipper compartment with wrap-around closure; flat front zipper pocket; padded back with concealed zipper compartment; length-adjustable padded shoulder straps with height- and width-adjustable chest strap; handle

Material: Polyester 1680d

Size (cm): W 30 x H 51/60 x D 15

Packing (pcs): 20

Decoration area (cm, silkscreen): on front pocket W 11 x H 16

Decoration possibilities: silkscreen print; embroidery; transfer print; doming; digitally printed label; metal emblem

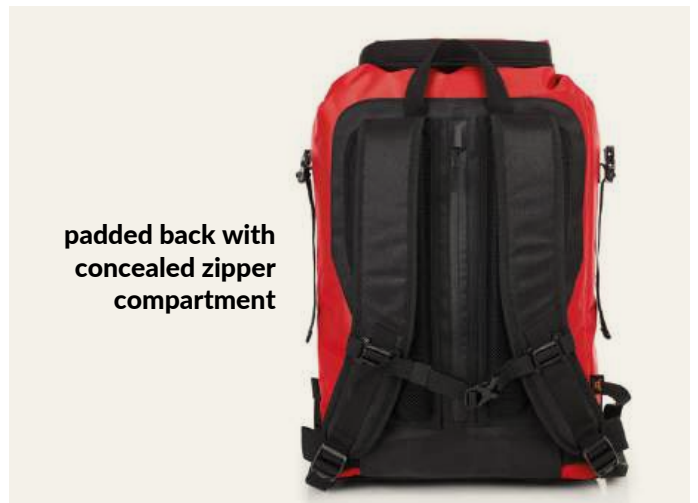

**padded back with
concealed zipper
compartment**



red (5)

black (1)

BACKPACKS FOR BUSINESS



new



black (1)



1816511 KURIER NOTEBOOK BACKPACK

large courier style backpack; main compartment with zipper and additional buckle; large front pocket with zipper; decorative reflective print on the front; flat pocket inside; airtag compartment; notebook compartment, also accessible from the back; reinforced base; padded carrying system with height adjustable chest strap; waist strap; handle

Material: tarpaulin
 Size (cm): W 35 x H 47 x D 15
 Packing (pcs): 10
 Decoration area (cm, silkscreen): on front pocket W 17 x H 18
 Decoration possibilities: silkscreen print; embroidery; digitally printed label; metal emblem; doming



black (1)

navy (3)

medium grey (115)



RECYCLED
PET 



light-grey sprinkle (728)

upholstered
notebook
compartment



green sprinkle (717)



blue sprinkle (716)



red sprinkle (746)



black sprinkle (678)



grey sprinkle (638)



1816514 EUROPE NOTEBOOK BACKPACK

streamlined backpack: rPET outer material; large main compartment with 2-way zip and padded notebook compartment; front pocket with zip; elaborately padded back with hidden zip compartment; length-adjustable padded shoulder straps with rubber loops to attach items such as sunglasses; handle

Material: rPET 600d

Size (cm): W 28 x H 42 x D 12

Packing (pcs): 20

Decoration area (cm, silkscreen): on front pocket W 16 x H 20; on the front W 19 x H 8,5

Decoration possibilities: silkscreen print; embroidery; transfer print; digitally printed label; metal emblem



RECYCLED
PET 



green sprinkle (717)

upholstered
notebook
compartment



blue sprinkle (716)



red sprinkle (746)



black sprinkle (678)



grey sprinkle (638)



light-grey sprinkle (728)



1816510 EUROPE NOTEBOOK ROLLTOP BACKPACK

urban backpack with magnetic and roll closure; spacious main compartment with padded notebook compartment; rPET outer material; back pocket with zip; elaborately padded back with hidden zip compartment; padded base; length-adjustable padded shoulder straps with rubber loops to attach items such as sunglasses; handle

Material: rPET 600d

Size (cm): W 32 x H 48/66 x D 14,5

Packing (pcs): 10

Decoration area (cm, silkscreen): on the front W 22 x H 29

Decoration possibilities: silkscreen print; embroidery; transfer print; digitally printed label; metal emblem



blue sprinkle (716)



- 18 l**
- ~15"**
- anti theft**
- recycling symbol**
- PVC free**
- serial**
- IATA**

1816517 EUROPE LAPTOP BACKPACK

streamlined, modern backpack; main compartment with zip and padded notebook compartment; rPET outer material; high-quality metal accessories; padded base; elaborately padded back with hidden zip compartment; length-adjustable padded shoulder straps with rubber loops to attach items such as sunglasses; handles

Material: rPET 600d
 Size (cm): W 32 x H 48 x D 15
 Packing (pcs): 10
 Decoration area (cm, silkscreen): on the front W 22 x H 32
 Decoration possibilities: silkscreen print; embroidery; transfer print; digitally printed label; metal emblem



green sprinkle (717) blue sprinkle (716) red sprinkle (746)

black sprinkle (678) grey sprinkle (638) light-grey sprinkle (728)



dark green (44)

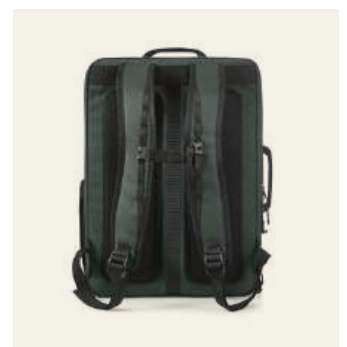

1818015 ACTIVE TRAVEL BACKPACK

spacious and elaborately crafted business travel backpack; large front zipped pocket and functional loop strap; side slip-in pocket for drink bottles, for example; two handles; large padded main luggage compartment with mesh lid, 2-way zip and side mesh pocket and key strap; two zipped mesh pockets in the main compartment lid; main compartment volume extension; separately accessible 2-way zipped compartment for work equipment: Tablet and notebook compartment, both with velour lining and elastic fastening loop; mesh pocket; slip-in pocket suitable for A4 documents; pen loop; well-padded back carrying system with adjustable chest strap; fastening loop for trolley bar on the back

Material: rPET 600d
Size (cm): W 34 x H 47 x D 20
Packing (pcs): 5

Decoration area (cm, silkscreen): on front pocket W 16 x H 24
Decoration possibilities: silkscreen print; embroidery; transfer print; metal emblem; digitally printed label; doming



black (1)



dark green (44)



pigeon blue (455)



mustard yellow (742)



pigeon blue (455)



1818034 ACTIVE NOTEBOOK BACKPACK

elaborately made roll-top backpack; zipped main compartment with side buckles; padded slip-in pocket inside; large zipped front pocket; functional strap band on the front; attachment loop for trolley handle on the back; concealed zipped compartment; padded carrying system with height-adjustable chest strap; handle on both sides and back

Material: rPET 600d
 Size (cm): W 29 x H 41 x D 15
 Packing (pcs): 20

Decoration area (cm, silkscreen): on front pocket W 16 x H 19
 Decoration possibilities: silkscreen print; embroidery; digitally printed label; transfer print; doming; metal emblem

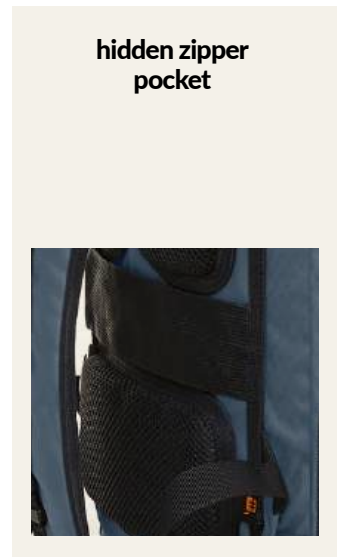



black (1)



1816086 **EXPERT** NOTEBOOK BACKPACK

elegant, streamlined business backpack; padded main compartment with two-way zip, organizer elements, padded pouch and zipped mesh compartment; large padded laptop pocket with separate access and cable opening to main compartment; zipped front pocket; elaborately padded back; padded fastening loop for trolley handle: adjustable, padded shoulder straps; reinforced handle

Material: Polyester 1680d & Polyester 600d

Size (cm): W 30 x H 43 x D 15

Packing (pcs): 10

Decoration area (cm, silkscreen): on the front W 18 x H 11

Decoration possibilities: silkscreen print; embroidery; transfer print; digitally printed label; metal emblem

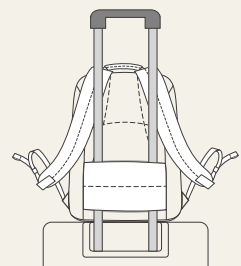

organiser function

fastening loop for
trolley

black (1)

upholstered
notebook
compartment



medium grey (115)

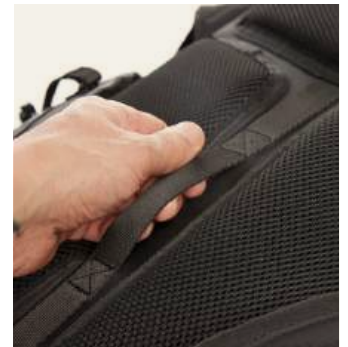

hidden zipper pocket



side pockets

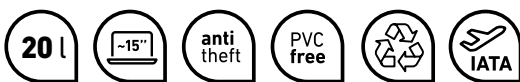

1819200 **ORBIT**
NOTEBOOK BACKPACK

dynamic roll-top backpack; zipped main compartment with buckle closure; large zipped front pocket; two side pockets; fixing straps; decorative reflective insert on the front; inside padded pocket with hook-and-loop fastening; hidden zipped compartment on the back; elaborately padded carrying system with individually adjustable chest strap; handle and carrying handle

Material: rPET soft PU
 Size (cm): W 30 x H 44,5/61 x D 16
 Packing (pcs): 10
 Decoration area (cm, silkscreen): on front pocket W 14 x H 11,5
 Decoration possibilities: silkscreen print; embroidery; transfer print; digitally printed label; metal emblem



olive (56)

medium grey (115)

black (1)



black (1)



night grey (723)

**padded
notebook
compartment**



**padded
notebook
compartment**



1812203 **IMPULSE** NOTEBOOK BACKPACK

generously padded main compartment with laptop compartment; front pocket with zipper, decorative stitching and organizer; side mesh pockets; padded handle; padded back; padded, ergonomically shaped shoulder straps

Material: Polyester 1680d
Size (cm): W 33 x H 48 x D 12
Packing (pcs): 10

Decoration area (cm, silkscreen): on front pocket W 12 x H 6
Decoration possibilities: silkscreen print; transfer print; embroidery; digitally printed label; metal emblem; doming



1809998 **PREMIUM** NOTEBOOK BACKPACK

elaborately crafted notebook backpack with reflex trim; padded handle; main compartment with 2-way zipper; front pocket with 2-way zipper and organizer; zipper pocket with velour lining and water resistant zipper; lateral mesh pockets; zipper pocket on the side that can hold an umbrella; padded bottom and back; padded straps with height adjustable chest strap

Material: Polyester two-tone
Size (cm): W 33 x H 49 x D 18
Packing (pcs): 10

Decoration area (cm, silkscreen): on front pocket W 17 x H 17
Decoration possibilities: silkscreen print; transfer print; embroidery; digitally printed label; doming



RECYCLED
PET 

new



beige (198)



black (1)

navy (3)

beige (198)

green-grey (644)

1818069 **SOLID** NOTEBOOK BACKPACK

high-quality, modern notebook backpack with recycled outer fabric; fully padded main compartment with three-sided 2-way zipper for convenient packing; bright inner lining for optimal visibility; large padded front pocket with 2-way zipper and insulating function, ideal e.g. for a lunchbox; additional flat zipper pouch; flat zipper pocket on the lid; two zipper side pockets; inside: padded notebook compartment with fastening strap, concealed AirTag pouch, zipper mesh pocket; ergonomically padded carrying system with adjustable chest strap; strap for fastening to trolley bar; handle

Material: rPET 900d

Size (cm): W 30 x H 47 x D 17

Packing (pcs): 10

Decoration area (cm, transfer print): on front pocket W 18 x H 14

Decoration possibilities: silkscreen print; transfer print; embroidery; digitally printed label; doming; metal emblem



HALFAR
FAST
LANE®



black-grey sprinkle (740)



1816052 FRAME NOTEBOOK BACKPACK

padded business backpack with elaborately-stitched front and HFL® carrier for your logo; padded main compartment with flat insert compartment suitable for DIN A4 documents; zip front pocket, with two flat insert pockets; padded zip notebook compartment; padded back with hidden zip compartment, also suitable for attachment to trolley rods; adjustable padded shoulder straps; padded handle

Material: Polyester 900d

Size (cm): W 33 x H 46 x D 12

Packing (pcs): 10

Decoration area (cm, HFL® sticker): on HFL® carrier W 5,7 x H 2,3

Decoration possibilities: HALFAR FAST LANE®



1815008 HASHTAG





black (1)



1815008 HASHTAG NOTEBOOK BACKPACK

elaborately-crafted business backpack, with reflective trim and LED bicycle light fastening option; large main compartment with 2-way zipper, notebook compartment for 15" notebooks, padded zipped inner pocket and flat zipped pocket; large 2-way zipped compartment with velour lining, suitable for 17" notebook; zipper pocket on the front; two elastic mesh pockets on the side, two hidden zipper pockets; rear fastening loop for trolley poles, hidden zipper pocket, USB port with integrated connecting cable; padded carrying system with removable, length-adjustable and elastic chest strap, elastic loops, e.g. for spectacle earpiece and elastic zipper mesh pocket; padded handle; zipper puller (on front) available in colours shown

Material: Polyester 1680d
Size (cm): W 33 x H 48 x D 18,5
Packing (pcs): 10

Decoration area (cm, silkscreen): on front pocket W 12 x H 6
Decoration possibilities: silkscreen print; embroidery; doming; metal emblem; digitally printed label



fastening loop for trolley



elastic mesh pockets



LED bicycle light fastening option



USB port + connecting cable



hidden zipper pockets





beige (22)



key ring

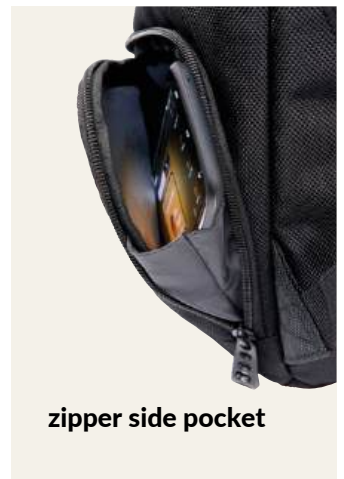

zipper side pocket



1807798 MISSION NOTEBOOK BACKPACK

versatile notebook backpack; main compartment with padded laptop compartment and inside open pocket; large padded zippered front pocket with various sewn in pouches, key ring and mobile phone pocket; zipper front pocket; zipper side pockets; padded back and shoulder straps; padded handle

Material: Polyester 1680d
Size (cm): W 30 x H 43 x D 14
Packing (pcs): 10

Decoration area (cm, silkscreen): on front pocket W 16 x H 16
Decoration possibilities: silkscreen print; transfer print; embroidery; digitally printed label; metal emblem; doming



padded notebook compartment



taupe (220)



navy (3)



black (1)



beige (22)



black (1)



1814008 **GIANT** BUSINESS NOTEBOOK BACKPACK

padded business backpack with rear side closure; padded main compartment with 3 zipper compartments; padded separator in the main compartment with flat inside compartment suitable for A4 documents; padded notebook compartment in the rear inner side; also 3 padded inside compartments suitable for tablets, mobile telephones; a compartment with RFID shielding; also a front zipper compartment with flat inside compartment; front pocket with concealed zipper; padded back with concealed zipper compartment under the padding; rear-side attachment loop for trolley frame; length-adjustable padded shoulder straps with height- and width-adjustable chest strap; padded handle

Material: Polyester 1680d
Size (cm): W 33 x H 46 x D 12

Packing (pcs): 10

Decoration area (cm, silkscreen): on front pocket W 12 x H 22

Decoration possibilities: silkscreen print; embroidery; transfer print; digitally printed label; metal emblem

fastening loop for trolley



three zipper compartments



hidden zipper pocket



padded notebook compartment

SPORTS BACKPACKS AND ACCESSORIES



new



beige (22)



 **WATER REPELLENT**

-  22 l
-  PVC free
- 
-  IATA
- 

1818054 EXPLORE BACKPACK

highly functional, waterproof leisure backpack; roll-top closure system with side buckles; rubber loop for excess strap material; sealed seams; elastic mesh side pockets; loop strap on front; hanging zipped compartment on the inside; padded carrying system with individually adjustable chest strap; handle

Material: Cotton/Polyester
 Size (cm): W 24 x H 45 x D 19
 Packing (pcs.): 10
 Print area (cm, silkscreen) on the front W 10 x H 32
 Decoration possibilities: silkscreen print; transfer print

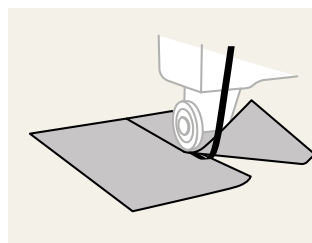

welded seams



black (1)



beige (22)



navy (3)



1818025 OUTDOOR BACKPACK

lightweight, functional backpack with ergonomically shaped back and innovative honeycomb back system for ideal ventilation and padding; height-adjustable at the top and bottom for a perfect fit; height-adjustable chest belt; padded pelvic strap with zipped pockets; large 2-way zipped main compartment with flat slip-in pocket inside; rear port suitable for headphones or tube of the optional hydration system (item 1812216); hook-and-loop strap for fixing the hydration tube; two zipped front pockets; two mesh side pockets; side lashing straps; functional strap band; decorative reflective print; trekking pole fixation, base compartment with rain cover; hand grip

Material: rPET ripstop
 Size (cm): W 31 x H 53 x D 20
 Packing (pcs): 10
 Decoration area (cm, silkscreen): on front pocket W 10 x H 29
 Decoration possibilities: silkscreen print; transfer print; embroidery; digitally printed label; metal emblem; doming

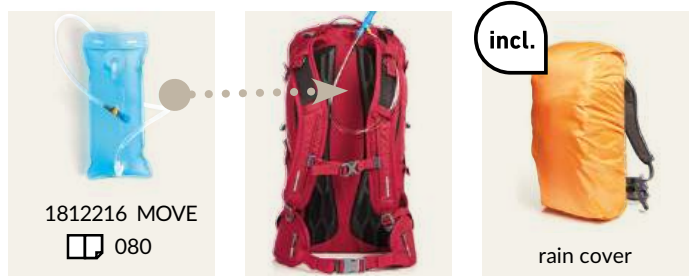



navy (3)



1818026 OUTDOOR DAYPACK

lightweight, functional day and bike backpack with innovative honeycomb back system for ideal ventilation and padding; height-adjustable chest strap; padded pelvic strap on the side; large 2-way zipped main compartment with flat slip-in pocket inside; rear port suitable for headphones or tube of the optional hydration system (item 1812216); hook-and-loop strap for fixing the hydration tube; two zipped front pockets; two mesh side pockets; side lashing straps; functional strap band; decorative reflective print, hand grip

Material: rPET ripstop
 Size (cm): W 27 x H 48 x D 12
 Packing (pcs): 25
 Decoration area (cm, silkscreen): on front pocket W 8 x H 18; on upper front pocket W 13 x H 9
 Decoration possibilities: silkscreen print; transfer print; embroidery; digitally printed label; metal emblem; doming

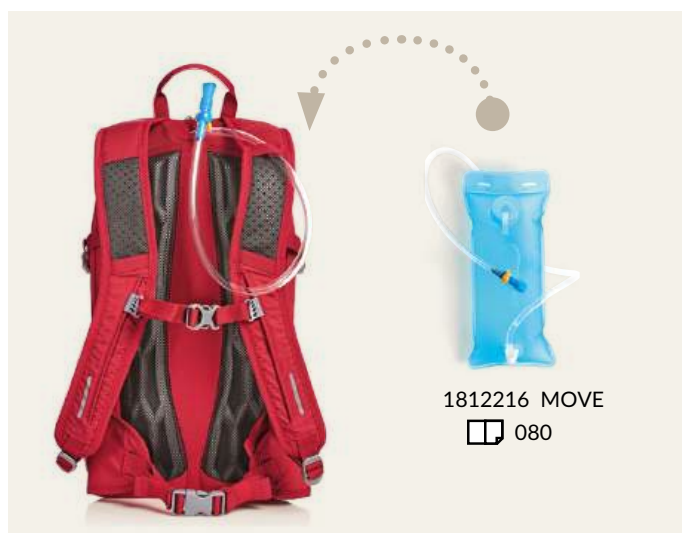

1812216 MOVE
 080

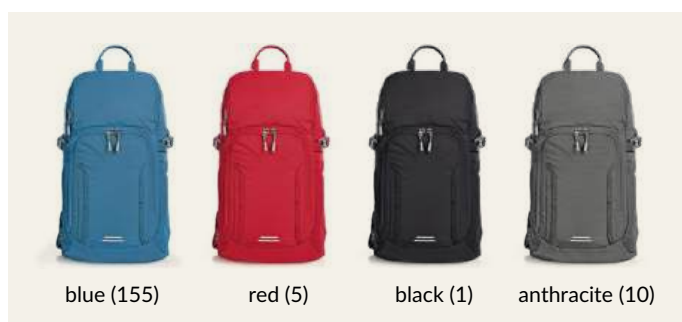

blue (155) red (5) black (1) anthracite (10)



apple green (187)



1809123 TRAIL BACKPACK

light, functional backpack with optimally padded back; large main compartment with insert pocket and headphone output; two outer side pockets; hiking pole fixing; lateral straps; bottom compartment with rain cover; padded shoulder straps with upper and lower length adjustment; padded lap strap with zipper pockets; adjustable chest strap

Material: Polyester 420d & ripstop

Size (cm): W 30 x H 49 x D 18

Packing (pcs): 10

Decoration area (cm, silkscreen): on front pocket W 11 x H 10

Decoration possibilities: silkscreen print; transfer print; embroidery; digitally printed label; doming; metal emblem



cyan (652)

orange (169)

white (18)

red (5)

apple green (187)

black (1)



white (18)



navy (3)



black (1)

cyan (652)

white (18)

apple green (187)

red (5)

navy (3)



black (1)

cyan (652)

white (18)

apple green (187)

red (5)

navy (3)



1813062 **STEP M** BACKPACK

spacious two-way zipper main compartment and insert pocket; lateral lashing straps; zipper front pocket with two insert pouches; reflective strap on the front; lateral mesh pouches; headphone opening; padded shoulder straps with height-adjustable, elastic chest strap; padded back

Material: Polyester 420d & ripstop

Size (cm): W 30 x H 42 x D 14

Packing (pcs): 20

Decoration area (cm, silkscreen): on front pocket W 11 x H 18

Decoration possibilities: silkscreen print; embroidery; transfer print; digitally printed label; doming; metal emblem



1813063 **STEP L** BACKPACK

spacious two-way zipper main compartment and insert pocket; lateral lashing straps; zipper front pocket with two insert pouches; reflective strap on the front; lateral mesh pouches; headphone opening; padded shoulder straps with height-adjustable, elastic chest strap; padded back

Material: Polyester 420d & ripstop

Size (cm): W 34 x H 49 x D 18,5

Packing (pcs): 25

Decoration area (cm, silkscreen): on front pocket W 14 x H 22

Decoration possibilities: silkscreen print; embroidery; transfer print; digitally printed label; doming; metal emblem



red (5)



orange (169)



black (1)



navy (3)



1803310 CITY DAYPACK

main compartment; zipper front pocket with organizer features; sew-in pouch; opening for headphone; padded back and shoulder strap

Material: Polyester 600d
 Size (cm): W 28,5 x H 42 x D 17
 Packing (pcs): 25
 Decoration area (cm, silkscreen): on front pocket W 15 x H 15
 Decoration possibilities: silkscreen print; transfer print; embroidery; digitally printed label; metal emblem; doming



net mesh
 compartment
 which can be
 stored into the
 base



volume
 expansion
 possible



black (1)



navy (3)



red (5)



royal blue (8)



1815023 TEAM BACKPACK

classic all-rounder for leisure time; large main compartment with 2-way zipper; flat pocket; volume expansion; 2-way zipper front pocket; bottom pocket with retractable mesh; elastic mesh side pockets; two handles; carrying strap; adjustable chest strap; padded, length-adjustable carrying system

Material: Polyester 600d
 Size (cm): W 32 x H 48 x D 17,5/22,5
 Packing (pcs): 20
 Decoration area (cm, silkscreen): on front pocket W 17 x H 26,5
 Decoration possibilities: silkscreen print; embroidery; doming; metal emblem; transfer print; digitally printed label



black (1)



navy (3)

red (5)

black (1)

apple green (187)

white (18)



1800780 **SPORT** BACKPACK

main compartment with padded pocket; opening for earplugs; two zipper front pockets; padded back and ergonomically shaped shoulder straps; waist strap; decorative mesh and cord trimming

Material: Nylon 420d
Size (cm): W 30 x H 41 x D 14
Packing (pcs): 25

Decoration area (cm, silkscreen): above front pocket W 10 x H 6
Decoration possibilities: silkscreen print; transfer print; embroidery; digitally printed label; metal emblem; doming



1806694 **GALAXY** BACKPACK

large main compartment with flat pouch; lateral mesh pockets and straps; big zipper front pocket with insert pouches and headset opening; beautifully designed and padded shoulder straps

Material: Nylon 420d & Jacquard
Size (cm): W 31 x H 48 x D 16
Packing (pcs): 25
Decoration area (cm, silkscreen): on front pocket, max. 1-coloured W 10 x H 20
Decoration possibilities: silkscreen print; transfer print; embroidery; digitally printed label; metal emblem; doming



1818025 Outdoor
1818026 Outdoor

blue (155)



1812216 **MOVE** DRINK SYSTEM

2 litres volume; ideal for various backpacks; food safe; tasteless;
flexible drinking tube with bite valve

Material: PEVA & TPU
Size (cm): W 17,5 x H 39
Packing (pcs): 25
Decoration area: -
Decoration possibilities: -



new



neon yellow (32)



1816512 REFLEX RAIN COVER

innovative rain cover for backpacks, universal size, individually adjustable thanks to elastic cord with stopper; ideal for backpacks with a packing volume of up to 26 L; lengthways and transverse fixation for a secure hold; neon yellow with reflective stripes; folds up and can be stowed away to save space

Material: Polyester 190t

Size (cm): W 73 x D 75

Packing (pcs.): 100

Print area (cm, transfer) on folded front W 9 x 20; on the entire front W 26 x H 20

Decoration possibilities: silkscreen print; transfer print



flat folded for a
high-quality presentation

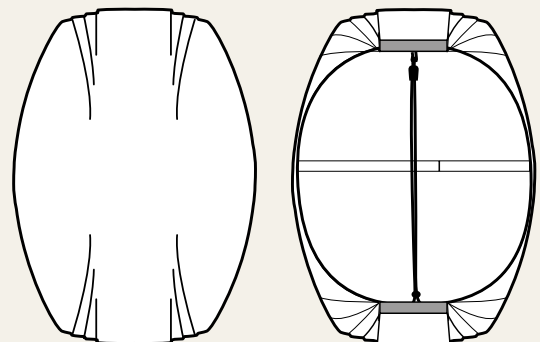



royal blue (8)



red (5)

welded Seams

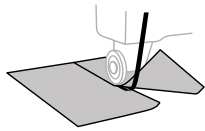

WATER REPELLENT

1809787 + 1809786



yellow (4)



orange (11)



red (5)



black matt (336)



light grey (2)



white (18)



royal blue (8)



1809787 SPLASH 2 DRYBAG

water-resistant, large main compartment with roll closure; removable adjustable shoulder strap

Material: tarpaulin

Size (cm): W 30 x H 59 x D 19,5

Packing (pcs): 25

Decoration area (cm, silkscreen): on the front W 20 x H 30

Decoration possibilities: silkscreen print



1809786 SPLASH DRYBAG

water-resistant, large main compartment with roll closure; removable adjustable shoulder strap

Material: tarpaulin

Size (cm): W 23 x H 51 x D 15

Packing (pcs): 25

Decoration area (cm, silkscreen): on the front W 16 x H 30

Decoration possibilities: silkscreen print



**WATER
REPELLENT**



red (5)

welded Seams

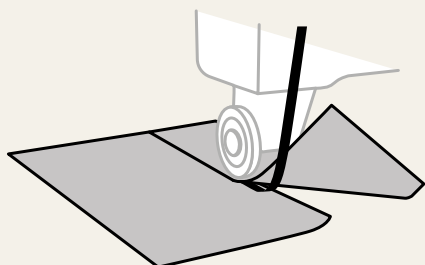

black matt (336)

apple green (187)

royal blue (8)

red (5)



1812214 **SPLASH** BACKPACK

large, spacious main compartment with welded seams and roll closure offering protection against dust and water; comfortable backpack carrying system

Material: tarpaulin

Size (cm): W 32,5 x H 70 x D 21,5

Packing (pcs): 20

Decoration area (cm, silkscreen): on the front W 20 x H 30

Decoration possibilities: silkscreen print



red (5)

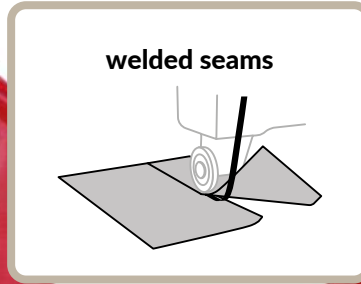

welded seams



red (5)



LIGHT WEIGHT



WATER REPELLENT



black (1)

silver (89)

red (5)

navy (3)



1818027 SAFE 6 L DRYBAG

lightweight pack sack to protect against dirt, dust and moisture; main compartment with wrap-around closure and sealed seams

Material: Polyester 210d ripstop

Size (cm): W 30 x H 40

Packing (pcs): 100

Decoration area (cm, silkscreen): on the front W 22 x H 28

Decoration possibilities: silkscreen print; transfer print



black (1)

silver (89)

red (5)

navy (3)



1818028 SAFE 1.4 L DRYBAG

lightweight pack sack to protect against dirt, dust and moisture; main compartment with wrap-around closure and sealed seams

Material: Polyester 210d ripstop

Size (cm): W 20 x H 25

Packing (pcs): 250

Decoration area (cm, silkscreen): on the front W 9 x H 14

Decoration possibilities: silkscreen print; transfer print

new



royal blue (8)

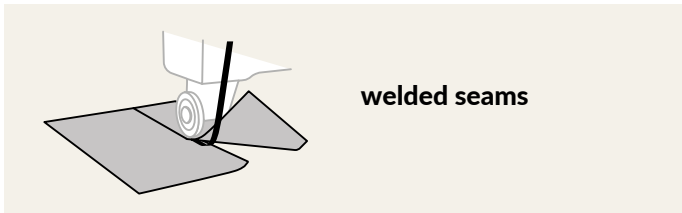

1818053 DRYBAG
ZIPPER BAG

practical zip-bag with water-repellent zipper to protect from dirt, dust and moisture; sealed seams; possible to wear on both sides thanks to the detachable hand strap

Material: Polyester 210d
 Size (cm): W 30 x H 18 x D 11
 Packing (pcs.): 200
 Print area (cm, silkscreen) on the front W 16 x H 8
 Decoration possibilities: silkscreen print; transfer print; doming



BICYCLE BAGS





anthracite (10)



anthracite (10)



1818050 **SOFTBASKET** **FELTLUNCHBAG**

timeless felt cooling bag; main compartment with 2-way zipper; generously padded; washable inside; detachable, length-adjustable strap on one side with G-hook and rubber tab for strap attachment; D-rings on both sides for attachment of optional shoulder strap* or keys for example; bottom feet; loops on back for attaching to bike handlebars

*Not included

Material: recycled PES felt
 Size (cm): W 26 x H 17 x D 15
 Packing (pcs): 20
 Decoration area (cm, silkscreen): on front pocket W 10 x H 5
 Decoration possibilities: embroidery; transfer print; metal emblem; digitally printed label; doming



jade green (19)



1818049 **SOFTBASKET** **LUNCHBAG**

stylish cooling bag; main compartment with 2-way zipper; generously padded; washable interior; detachable, adjustable strap on one side with G-hook and rubber flap for strap attachment; D-rings on both sides for attachment of e. g.: optional shoulder strap* or keys; bottom feet; loops on back for attaching to bike handlebars

*Not included

Material: rPET 600d
 Size (cm): W 26 x H 17 x D 15
 Packing (pcs): 20
 Decoration area (cm, silkscreen): on front pocket W 16 x H 7
 Decoration possibilities: silkscreen print; embroidery; transfer print; metal emblem; digitally printed label; doming



grey sprinkle (638)



1818011 CYCLE BIKE BAG

urban bike bag with spacious main compartment; large, inner pocket with zip; roll-top closure; welded seams for reliable protection against rainwater and moisture; bottom and edge protection; individually-adjustable bracket for luggage rack attachment with twist lock, for security and Velcro closure on the bottom back part of the bag for additional fixation; decorative reflector application; hand grip

Material: Polyester 600d

Size (cm): W 29 x H 36/60 x D 14

Packing (pcs): 10

Decoration area (cm, silkscreen): on the front W 23 x H 33

Decoration possibilities: silkscreen print; transfer print



grey sprinkle (638)



**bottom
and edge
protection**

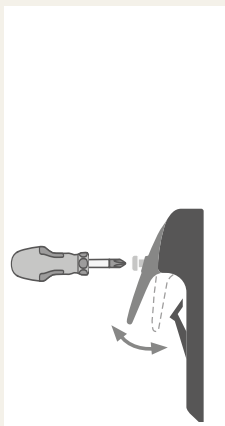

Click and bike.
Thanks to KLICKfix®,
the premium
holder system
by Rixen & Kaul.

- +** Extra short hooks
to suit most luggage racks
- +** Continuously adjustable
at Ø 8-16mm
- +** Sturdy hold and safety
with a twist catch and
hook-and-loop flap





grey sprinkle (638)



1818012 CYCLE BICYCLE HANDLEBAR BAG

main compartment with roll closure on both sides for rapid access; front, with an elastic band for stowing, e. g. jacket, sweater, etc.; front pocket with zip; welded seams for reliable rainwater and wetness protection; device for attaching a reflector or bicycle light; strap system, allowing attachment to bicycle handlebars

Material: Polyester 600d
Size (cm): W 30 x H 16 x D 16
Packing (pcs): 25

Decoration area (cm, silkscreen): on front pocket W 9 x H 7
Decoration possibilities: silkscreen print; transfer print

elastic band for
stowing jacket/
sweater





grey sprinkle (638)



fastening system

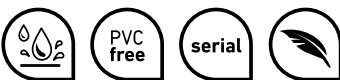

1818013 **CYCLE** BICYCLE FRAME BAG

main compartment, with variably-adjustable mobile phone compartment and transparent protective film for operating the touch screen; water-repellent zip; welded seams for reliable protection against rainwater and wetness; mounting with individually-adjustable, adhesive Velcro fasteners, can be individually removed if required; padded bottom

Material: Polyester 600d

Size (cm): W 10,5 x H 8 x D 19

Packing (pcs): 20

Decoration area (cm, silkscreen): on the side W 9 x H 2

Decoration possibilities: silkscreen print; transfer print







caramel (272)

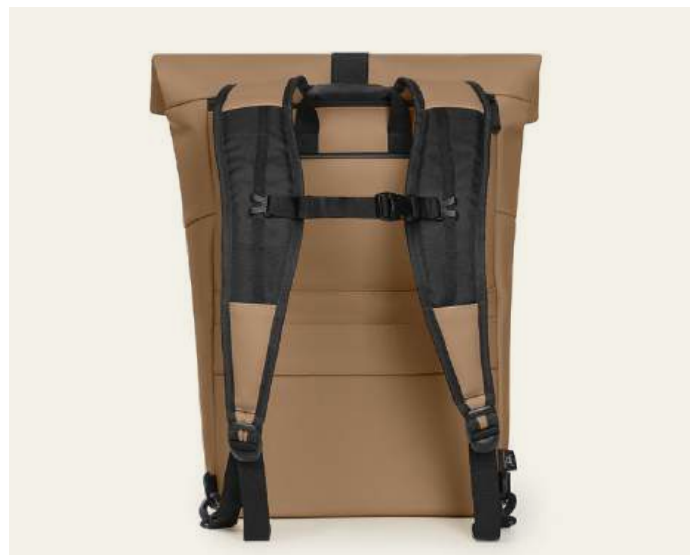

1818063 ORBIT BIKE BACKPACK

dynamic roll-top backpack with waterproof zippers; recycled outer fabric with water-repellent effect; zippered main compartment with additional buckle; large zippered front pocket; decorative reflective print on front and sides; padded inside pocket with Velcro fastener; AirTag pocket; attachment loop for trolley handles; bike rack holders on the back; retractable, padded shoulder straps with individually adjustable chest strap; handle

Material: rPET soft PU

Size (cm): W 30 x H 44,5 x D 17

Packing (pcs): 10

Decoration area (cm, silkscreen): on front pocket W 14 x H 11,5

Decoration possibilities: silkscreen print; embroidery; transfer print; metal emblem; digitally printed label



black (1)



olive (56)



caramel (272)

SHOULDER BAGS





mustard yellow (742)

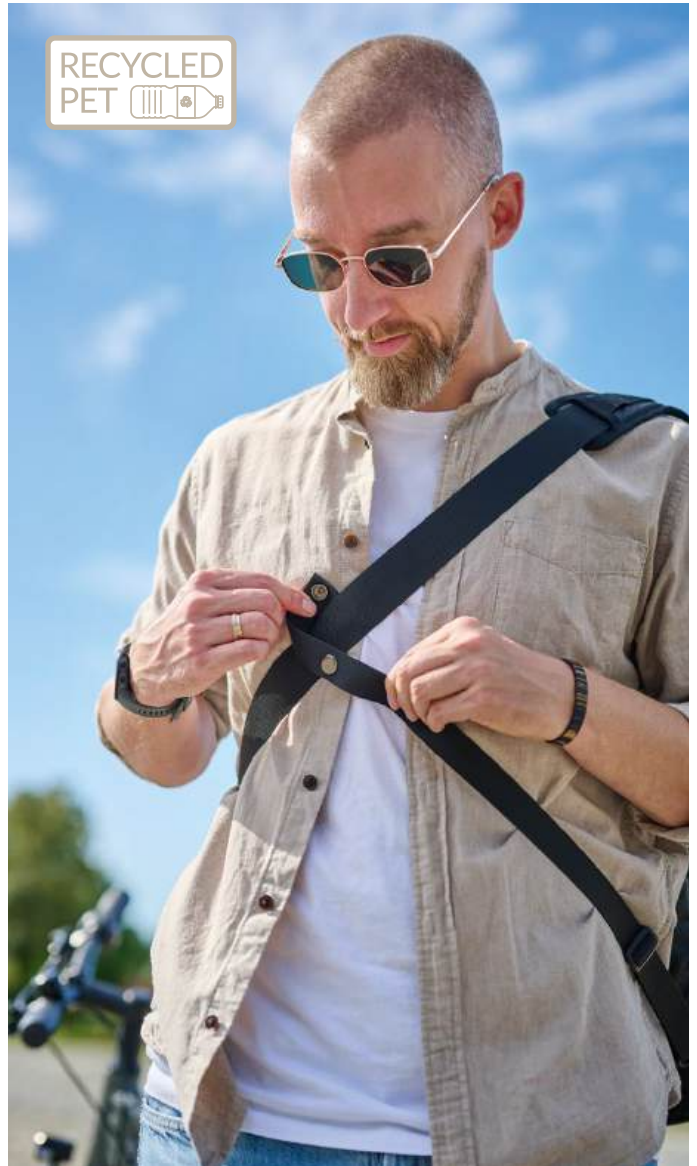

1818043 ACTIVE
NOTEBOOK BAG

dynamic notebook bag; flap with 2-way zip, functional loop strap, side buckles; for use as volume expansion; large main compartment with quick access; padded notebook compartment with hook-and-loop tab; two slip-in pockets inside; zipped front pocket; handle and fastening loop for trolley handles; concealed zipped pocket on the back; padded back; padded base; length-adjustable shoulder strap on both sides with sewn shoulder pad; flexible waistband fixing - ideal for cycling

Material: rPET 600d
Size (cm): W 40 x H 32 x D 12
Packing (pcs): 10

Decoration area (cm, silkscreen): on front pocket W 22 x H 17
Decoration possibilities: silkscreen print; embroidery; transfer print; metal emblem; digitally printed label; doming



black (1)



dark green (44)



pigeon blue (455)



mustard yellow (742)





orange (11)



1802814 ECONOMY
LORRYBAG®

spacious main compartment with organizer features and flat inside pocket; wide shoulder strap; large flap (i. e. large decoration area) with hook and loop tape fastener

Material: tarpaulin
Size (cm): W 37 x H 29 x D 13
Packing (pcs): 20
Decoration area (cm, silkscreen): on the flap W 25 x H 20
Decoration possibilities: silkscreen print; embroidery; digitally printed label; metal emblem





navy (3)



1806052 **STYLE** SHOULDER BAG

spacious main compartment with organizer features and flat inside pocket; wide shoulder strap; large flap (i. e. large decoration area) with hook and loop tape fastener

Material: tarpaulin

Size (cm): W 37 x H 28 x D 12

Packing (pcs): 20

Decoration area (cm, silkscreen): on the flap W 25 x H 20

Decoration possibilities: silkscreen print; embroidery; digitally printed label; metal emblem



navy (3)



anthracite (10)



anthracite (10)



black (1)



anthracite (10)



1815029 FLOW CROSSBAG

small, functional shoulder bag; main compartment with flat zip front pocket; length-adjustable shoulder strap

Material: Polyester 600d

Size (cm): W 14 x H 18 x D 5,5

Packing (pcs): 100

Decoration area (cm, silkscreen): on front pocket W 7 x H 7

Decoration possibilities: silkscreen print; embroidery; doming; metal emblem





black-grey sprinkle (740)



black-grey sprinkle (740)

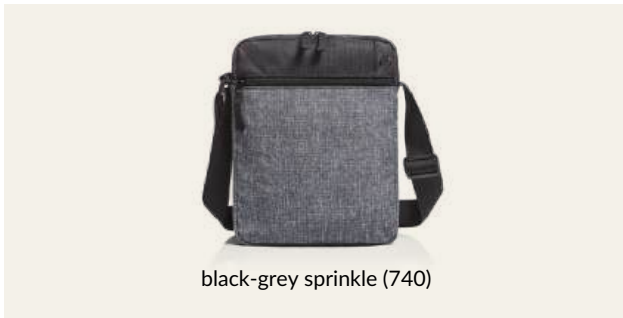

black-grey sprinkle (740)

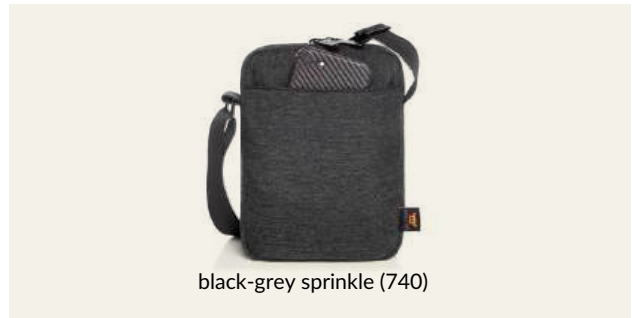

black-grey sprinkle (740)



1814026 ELEGANCE
CROSSBAG

small, functional shoulder bag; main compartment with 2-way zipper and organizer elements; padded back; padded, flat compartment for tablets, for example; headphone output; zipper front pocket; length-adjustable shoulder strap

Material: Polyester 300d melange

Size (cm): W 22 x H 28 x D 5

Packing (pcs): 50

Decoration area (cm, silkscreen): on front pocket W 14 x H 15

Decoration possibilities: silkscreen print; embroidery; transfer print; digitally printed label; metal emblem



1816057 FRAME
CROSSBAG

small, padded shoulder bag; main compartment with 2-way zip; zip front pocket, with elaborately-stitched front and HFL® carrier for your logo; flat rear pocket; adjustable shoulder strap with high-quality metal accessories

Material: Polyester 900d

Size (cm): W 15 x H 20 x D 4

Packing (pcs): 25

Decoration area (cm, HFL® sticker): on HFL® carrier W 5,7 x H 2,3

Decoration possibilities: HALFAR FAST LANE®



black-grey sprinkle (740)



1816051 FRAME NOTEBOOK BAG

elegant shopper; elaborately-stitched front with HFL® carrier for your logo; zip main compartment with notebook compartment; two mesh pockets; large mesh zip compartment inside; flat pockets with magnetic closure outside; retractable handles; detachable, length-adjustable shoulder strap, with high-quality metal accessories

Material: Polyester 900d

Size (cm): W 30 x H 42 x D 13

Packing (pcs): 10

Decoration area (cm, HFL® sticker): on HFL® carrier W 5,7 x H 2,3

Decoration possibilities: HALFAR FAST LANE®



nature (704)



grey (54)

nature (704)



1816066 LOOM SHOULDER BAG

large zipped main compartment with padded back and metal fastening; padded base; flat pouch; zipped pocket on back; adjustable shoulder strap; high quality metal accessories

Material: cotton/Polyester

Size (cm): W 35 x H 30 x D 13

Packing (pcs): 25

Decoration area (cm, silkscreen): on the front W 28 x H 18

Decoration possibilities: silkscreen print; embroidery; transfer print; digitally printed label; metal emblem



nature (704)



grey (54)

nature (704)

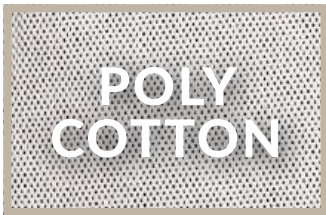

1816067 **LOOM** MULTI BAG

innovative multi-functional bag for use as backpack or shoulder bag; zipped main compartment; zipped inside pocket

Material: cotton/Polyester

Size (cm): W 32 x H 40 x D 9

Packing (pcs): 50

Decoration area (cm, silkscreen): on the front W 22 x H 33

Decoration possibilities: silkscreen print; embroidery; transfer print; digitally printed label; metal emblem



neon yellow (32)



neon yellow (32)



1812205 REFLEX SHOULDER BAG

large main compartment; flat insert pouch with organizer elements; zipper pocket on the flap; adjustable shoulder strap with sewn shoulder pad; bright neon yellow body fabric with 3M™ Scotchlite™ reflective strips

Material: Polyester 900d
Size (cm): W 35 x H 28 x D 12
Packing (pcs): 25

Decoration area (cm, silkscreen): on front pocket W 23 x H 9
Decoration possibilities: silkscreen print; transfer print; embroidery; doming; digitally printed label; metal emblem



navy (3)



1812220 KURIER SHOULDER BAG

spacious main compartment with organizer elements; flat inside compartment; padded back; length-adjustable shoulder strap; large flap with hook and loop tape fastener

Material: Polyester 600d
Size (cm): W 36 x H 29 x D 12
Packing (pcs): 25

Decoration area (cm, silkscreen): on the flap W 26 x H 23
Decoration possibilities: silkscreen print; embroidery; transfer print; digitally printed label; metal emblem



navy (3)



**1818038 EVENT
MULTI BAG**

versatile, functional companion with a large promotional space; main compartment with concealed zip, fits A4 documents; length-adjustable strap system, can be worn as a shoulder bag or backpack; handle

Material: rPET
 Size (cm): W 28 x H 35 x D 5
 Packing (pcs): 50
 Decoration area (cm, silkscreen): on the front W 15 x H 22
 Decoration possibilities: silkscreen print; embroidery; transfer print; digitally printed label; Metal emblem



jade green (19)

beige (198)

dark burgundy (745)

black (1)

navy (3)

anthracite (10)



khaki (739)



1816071 COUNTRY SHOULDER BAG

large, back-padded, zipped main compartment with padded pouch e. g. for tablet; flat zipped inside pocket; flat pocket on front; flap with magnet fastening and zipped front pocket; adjustable shoulder strap with sewn shoulder pad; high-quality metal accessories and PU velour artificial leather applications

Material: cotton 16 OZ (~453 g/m²)

Size (cm): W 34 x H 26 x D 10

Packing (pcs): 25

Decoration area (cm, silkscreen): on the flap W 22 x H 12

Decoration possibilities: silkscreen print; embroidery; transfer print; digitally printed label; metal emblem



navy (3)

khaki (739)

anthracite (10)



anthracite (10)



anthracite (10)



1813066 MODERNCLASSIC SHOULDER BAG

main compartment with organizer features ideal for A4 documents; flat insert pocket on the inside; length-adjustable poly cotton shoulder strap; large flap with hook and loop tape closure

Material: recycled PES felt
 Size (cm): W 31 x H 24 x D 11
 Packing (pcs): 20
 Decoration area (cm, embroidery): on the flap W 29 x H 20; on the front W 15 x H 14
 Decoration possibilities: embroidery; transfer print; digitally printed label; metal emblem



anthracite (10)

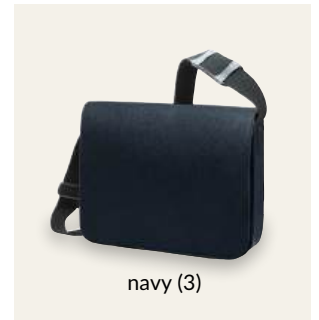

navy (3)



1807554 MODERNCLASSIC COURIER BAG

main compartment with organizer features; flat inside pocket; convenient shoulder strap; large flap with hook and loop tape closure as the ideal embroidery area for your promotion

Material: recycled PES felt
 Size (cm): W 37,5 x H 29 x D 10
 Packing (pcs): 20
 Decoration area (cm, embroidery): on the flap W 31 x H 18; on the front W 26 x H 14
 Decoration possibilities: embroidery; transfer print; digitally printed label; metal emblem



light-grey sprinkle (728)

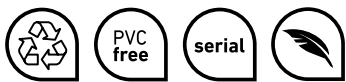

1816077 CIRCLE
SHOULDER BAG

modern shoulder bag; rPET upper material; spacious zipped main compartment; outer pocket with hidden zip; adjustable strap

Material: rPET 300d
 Size (cm): W 32 x H 38 x D 7
 Packing (pcs): 50
 Decoration area (cm, silkscreen): on front pocket W 20 x H 21
 Decoration possibilities: silkscreen print; embroidery; transfer print; doming; digitally printed label; metal emblem



green sprinkle (717)



light-grey sprinkle (728)



black sprinkle (678)



blue-grey sprinkle (722)

LAPTOP BAGS AND ORGANISERS





anthracite (10)



1818046 PROFESSIONAL ORGANIZER

organizer with extensive features; large main compartment; quick-opening function for mobile working; useable with and without flap; padded base; laptop holder; flat slip-in pocket on the front; two slip-in pockets on the back; two fastening loops for a drink bottle, for example; three flat slip-in pouches inside; three slip-in loops inside; flat zipped pocket inside; length-adjustable carrying straps

Material: recycled PES felt
 Size (cm): W 42 x H 27 x D 16
 Packing (pcs): 20
 Decoration area (cm, embroidery): on front pocket W 23 x H 12
 Decoration possibilities: embroidery; transfer print; digitally printed label; metal emblem; doming

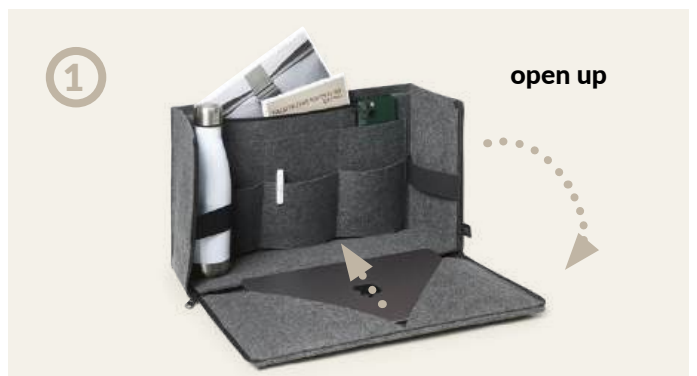



anthracite (10)



anthracite (10)



front side



back side



1818044 MODERNCLASSIC INLAY

practical inlay; main compartment suitable for A4 size documents; two deep compartments, one with individually adjustable separation; practical, elasticated fastening loops; handles

Material: recycled PES felt
 Size (cm): W 32,5 x H 21 x D 14
 Packing (pcs): 20
 Decoration area (cm, embroidery): on the front W 12,5 x H 4,5
 Decoration possibilities: embroidery; transfer print; digitally printed label; metal emblem



1818045 MODERNCLASSIC ZIPPER BAG

compact and elegant little bag made from recycled felt material; zip fastener; practical hand strap

Material: recycled PES felt
 Size (cm): W 24 x H 12 x D 3
 Packing (pcs): 50
 Decoration area (cm, embroidery): on the front W 9 x H 7
 Decoration possibilities: embroidery; transfer print; digitally printed label; metal emblem



anthracite (10)



1816075 MODERNCLASSIC ORGANIZER

extensively equipped organizer with large main compartment; flat pouch, zipped pouch, two attachment loops e. g. for drinks bottle, business card pocket, three inside pouches; three outside pouches; adjustable straps; fastening flap etc. for car belt

Material: recycled PES felt
Size (cm): W 45 x H 25 x D 15
Packing (pcs): 20

Decoration area (cm, embroidery): on front pocket W 9 x H 8
Decoration possibilities: embroidery; transfer print; digitally printed label; metal emblem

attachment for safety
belt

cup holder



anthracite (10)



1818029 MODERNCLASSIC ORGANIZER XL

extensively equipped organiser; large 2-way zipped main compartment; flat slip-in compartment, large zipped slip-in compartment, two fixing loops e. g. for water bottle, business card pocket, three slip-in compartments inside; three slip-in compartments outside; length-adjustable shoulder straps; fastening tab e. g. for car seat belts

Material: recycled PES felt
 Size (cm): W 50 x H 27 x D 16
 Packing (pcs): 20

Decoration area (cm, embroidery): on the front W 14 x H 8
 Decoration possibilities: embroidery; transfer print; digitally printed label; doming; metal emblem



attachment for safety belt

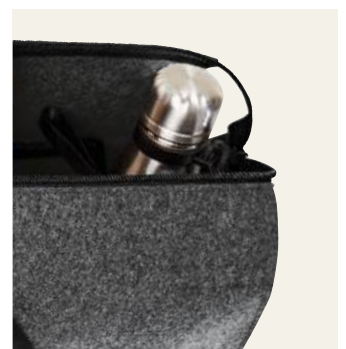

cup holder



blue-grey sprinkle (722)

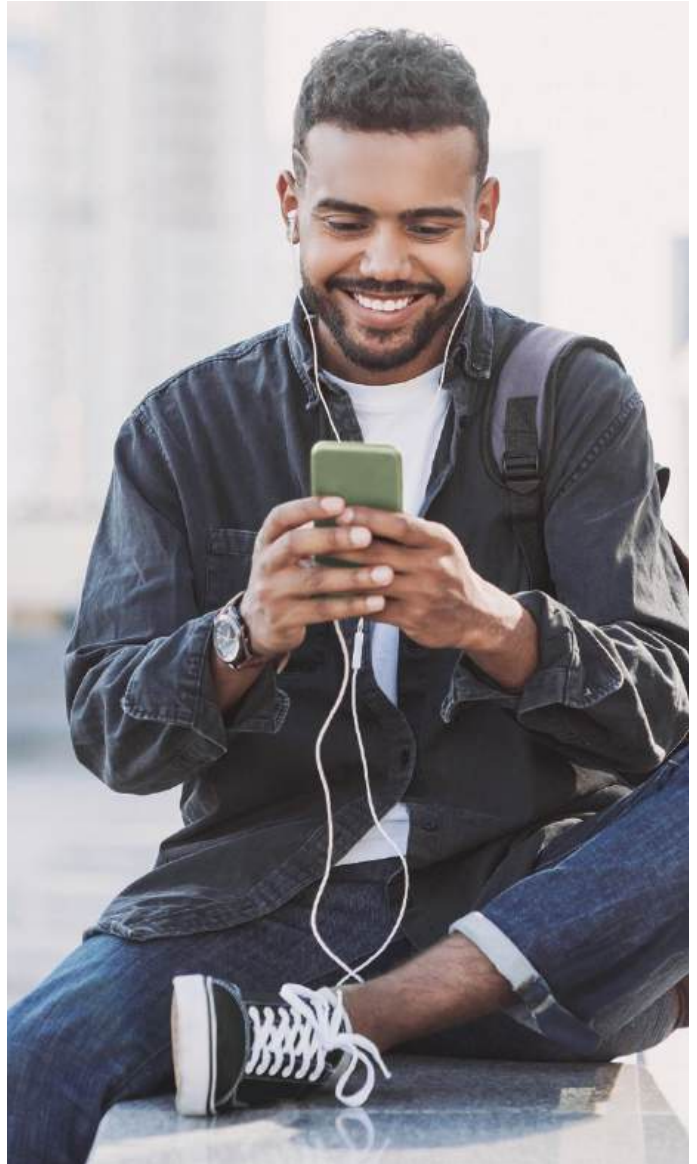

backpack function



notebook compartment



removable shoulder strap



1812199 ATTENTION COMBIBAG

comfortable business bag/backpack with sophisticated details; large, padded main compartment with notebook holder; bottom studs; front pocket with zipper and organizer elements; flat front pouch; two padded handles; removable and adjustable shoulder strap; retractable and padded backpack straps; height-adjustable chest strap

Material: Polyester 300d sprinkle

Size (cm): W 43 x H 31 x D 16

Packing (pcs): 10

Decoration area (cm, silkscreen): on front pocket W 23 x H 9

Decoration possibilities: silkscreen print; transfer print; embroidery; digitally printed label; metal emblem



navy (3)



1802765 **ECONOMY** LAPTOP BACKPACK

can be used as either backpack or shoulder bag; pocket for back-pack straps; several zipper front pockets; organizer features; padded main compartment for notebook; adjustable, detachable shoulder strap with non-slip shoulder pad

Material: Polyester Mini ripstop
Size (cm): W 39 x H 27 x D 10/14
Packing (pcs): 20

Decoration area (cm, silkscreen): on middle front pocket
W 7,5 x H 13

Decoration possibilities: silkscreen print; transfer print; embroi-
dery; digitally printed label; metal emblem; doming

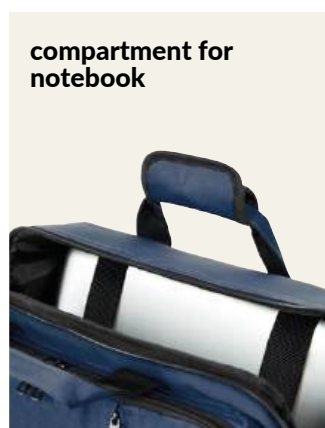



light-grey sprinkle (728)



1816515 EUROPE
NOTEBOOK BAG

large, padded main compartment on the back with 2-way zip; rPET outer material; high-quality metal accessories; padded pocket e. g. for notebooks; flat front pocket with zip; rear fastening for trolley poles; detachable, length-adjustable shoulder strap; handles

Material: rPET 600d
Size (cm): W 39 x H 29 x D 8
Packing (pcs): 20

Decoration area (cm, silkscreen): on front pocket W 22 x H 13
Decoration possibilities: silkscreen print; embroidery; metal emblem; transfer print; digitally printed label

fastening loop for trolley





navy-brown (308)



1816521 LIFE
NOTEBOOK BAG

modern, elaborately crafted notebook bag; lovingly designed with high-quality metal accessories and coated cotton trims; large 2-way-zipper main compartment; padded notebook compartment with flat insert pockets and pen loops; zipper inner pocket; securer zipper rear insert pocket; handles with press stud; adjustable, detachable cotton shoulder strap

Material: cotton 12 OZ (~340 g/m²)

Size (cm): W 40 x H 30 x D 8

Packing (pcs): 25

Decoration area (cm, silkscreen): on the front W 29 x H 8

Decoration possibilities: silkscreen print; transfer print; embroidery; digitally printed label; metal emblem

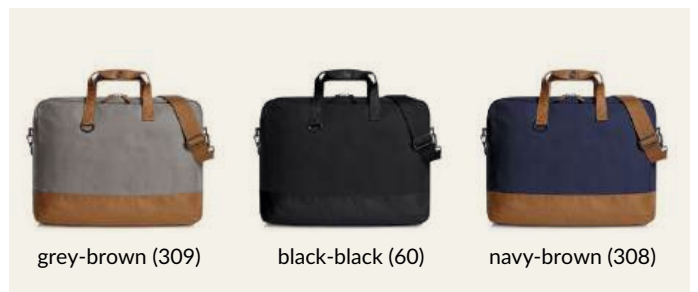

grey-brown (309)

black-black (60)

navy-brown (308)



black (1)

elaborately
quilted back

1815011 **LOFT** NOTEBOOK BAG

stylish notebook case with striking buckle closure; main compartment with zipper and zipper protection; padded on the side and back; notebook compartment; two flat, large zipper inner pockets; zipped side pocket; elaborately back-stitched and padded back; length-adjustable shoulder strap with sewn shoulder padding

Material: Polyester 600d high density

Size (cm): W 40 x H 30/42 x D 13

Packing (pcs): 20

Decoration area (cm, silkscreen): on the front W 28 x H 15

Decoration possibilities: silkscreen print; embroidery; metal emblem; transfer print; digitally printed label



black-grey sprinkle (740)

fastening loop
for trolley

1816050 **FRAME** NOTEBOOK BAG

comfortable business bag with elaborately-stitched front and HFL® carrier for your logo; large, padded main compartment with 2-way zip; notebook compartment; two flat mesh compartments; padded zipped front pocket with three mesh compartments; rear flat zip pocket, also suitable for attachment to trolley poles; handles with grip sleeve; detachable, length-adjustable shoulder strap with shoulder pad; high-quality metal accessories

Material: Polyester 900d

Size (cm): W 40 x H 30 x D 10

Packing (pcs): 10

Decoration area (cm, HFL® sticker®): on HFL® carrier W 5,7 x H 2,3

Decoration possibilities: HALFAR FAST LANE®



beige (22)



taupe (220)

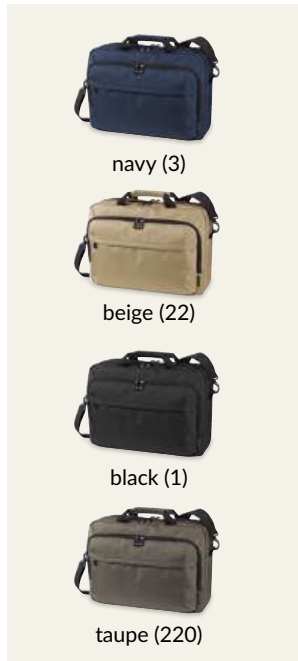

navy (3)

beige (22)

black (1)

taupe (220)

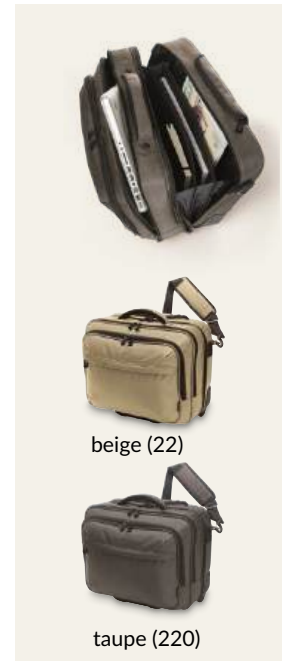

beige (22)

taupe (220)



1809108 MISSION BUSINESS BAG

padded main compartment with 2-way zipper, padded notebook compartment with elastic holder; zipper front pocket with organizer features; zippered front pocket; handles; removable, double-sided adjustable shoulder strap

Material: Polyester 1680d
Size (cm): W 44 x H 32 x D 15
Packing (pcs): 10

Decoration area (cm, silkscreen): on front pocket W 22 x H 10
Decoration possibilities: silkscreen print; transfer print; embroidery; digitally printed label; metal emblem

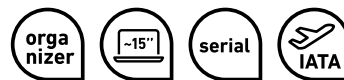

1812215 MISSION BUSINESS TROLLEY

generously padded laptop trolley, zipper compartment for notebook; document zipper compartment with separation; zipper front pocket with organizer features; zipper front pocket; handle; removable, adjustable shoulder strap with sewn shoulder pad; rear fixation for luggage trolley; telescopic handle

Material: Polyester 1680d
Size (cm): W 42 x H 33/38 x D 18
Packing (pcs): 2

Decoration area (cm, silkscreen): on front pocket W 23 x H 15
Decoration possibilities: silkscreen print; doming; metal emblem

FOLDERS AND COVERS





grey-brown (309)



black-grey sprinkle (740)



navy-brown (308)

black-black (60)

grey-brown (309)



1816522 LIFE SLEEVE

modern, elaborately crafted notebook sleeve; lovingly designed with coated cotton trim; suitable for notebooks and A4 size documents; two flat insert pockets on the front; zipper compartment on the flap inside; large zipper compartment on the back; magnetic clasp

Material: cotton 12 OZ (~340 g/m²)

Size (cm): W 39 x H 29 x D 3

Packing (pcs): 50

Decoration area (cm, silkscreen): on the flap W 26 x H 18

Decoration possibilities: silkscreen print; embroidery; metal emblem; transfer print; digitally printed label



1816053 FRAME SLEEVE

padded high-quality sleeve with elaborately-stitched front and HFL® carrier for your logo; suitable for notebook and A4 size notebooks; on the front, flat pocket with pen loop; large zip pocket on the back, suitable for A4 size documents; magnetic fastener

Material: Polyester 900d

Size (cm): W 39 x H 29 x D 3

Packing (pcs): 25

Decoration area (cm, HFL® sticker): on HFL® carrier W 5,7 x H 2,3

Decoration possibilities: HALFAR FAST LANE®



anthracite (10)



1816082 MODERNCLASSIC LAPTOP SLEEVE

high-quality felt cover for laptops; zipped front pocket; elastic band to close the flap

Material: recycled PES felt

Size (cm): W 42 x H 30

Packing (pcs): 50

Decoration area (cm, embroidery): on the flap W 36 x H 18

Decoration possibilities: embroidery; transfer print; digitally printed label; metal emblem



navy (3)



anthracite (10)

navy (3)



1809117 MODERNCLASSIC M SLEEVE

quality felt case suitable for A4 notebook and tablets; elastic band for closing the cover

Material: recycled PES felt

Size (cm): W 33 x H 23

Packing (pcs): 50

Decoration area (cm, embroidery): on the flap W 27 x H 6; on the front W 11 x H 11

Decoration possibilities: embroidery; transfer print; digitally printed label



anthracite (10)



1813056 **ECONOMY M** COVER

quality felt case suitable for A5 size writing pads; insert pocket for business cards; pen loop for closing the cover

Material: recycled PES felt
 Size (cm): W 17 x H 23 x D 1
 Packing (pcs): 200
 Decoration area (cm, embroidery): on the front W 7,5 x H 20
 Decoration possibilities: embroidery; transfer print; digitally printed label

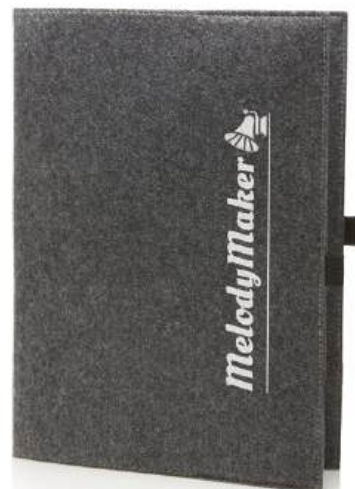

anthracite (10)



1809997 **ECONOMY** COVER

quality felt case suitable for A4 size diary; insert pockets; pen loop for closing the cover

Material: recycled PES felt
 Size (cm): W 24 x H 32 x D 1
 Packing (pcs): 100
 Decoration area (cm, embroidery): on the front W 9,5 x H 27,5
 Decoration possibilities: embroidery; transfer print; digitally printed label



black (1)



apple green (187)

ring binder



concertina bag



1802787 CONFERENCE FOLDER

CONFERENCE FOLDER

zipper conference folder with organiser features; writing pad and 2 ring binder; flat pocket; zipper pocket

Material: Polyester 600d

Size (cm): W 26 x H 35 x D 3

Packing (pcs): 20

Decoration area (cm, silkscreen): on front pocket W 11,5 x H 20

Decoration possibilities: silkscreen print; transfer print; metal emblem; doming

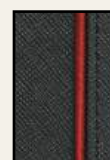

red (5)



apple green (187)

1813068 SCRIPT

CONFERENCE FOLDER

black conference folder with organizer features; closes with coloured elastic band; writing pad; flat insert pocket; elastic band for pens

Material: pu artificial leather

Size (cm): W 25 x H 32 x D 2

Packing (pcs): 25

Decoration area (cm, silkscreen): on the front, only one colour W 12,5 x H 25

Decoration possibilities: silkscreen print; embossing



light grey (2)



1815013 **WORK** CONFERENCE FOLDER

writing case with organizer elements; closable with zipper; flat pocket on the front; flat pocket inside; various card pockets; rubber loops, e.g. for USB drive, ballpoint pen etc.; hook and loop tape strap for setting up digital devices; incl. writing pad

Material: Polyester 300d

Size (cm): W 25,5 x H 34 x D 3,5

Packing (pcs): 20

Decoration area (cm, silkscreen): on front pocket, only one colour W 12 x H 20

Decoration possibilities: silkscreen print; metal emblem; transfer print



organiser loops

mobile phone holder

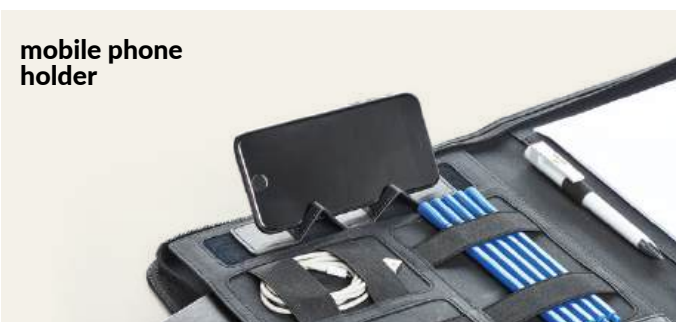

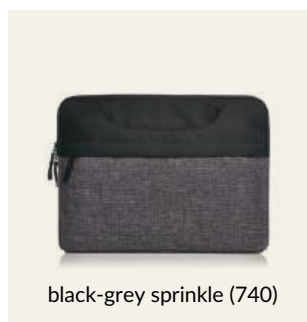

black-grey sprinkle (740)



1814034 ELEGANCE LAPTOP BAG

attractive, two-coloured laptop case; padded main compartment with 2-way zipper on the side for easy filling; front zipper pocket; flat pocket on the front and back; retractable carrying handles

Material: Polyester 300d melange

Size (cm): W 39 x H 29 x D 2,5

Packing (pcs): 25

Decoration area (cm, silkscreen): on front pocket W 23 x H 13

Decoration possibilities: silkscreen print; embroidery; metal emblem; transfer print; digitally printed label

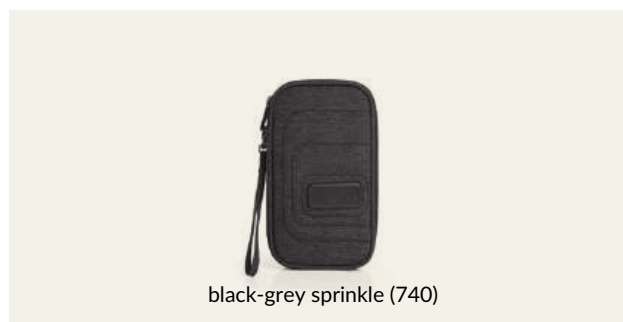

black-grey sprinkle (740)



1816056 FRAME ORGANIZER

organizer file with two zipped main compartments; removable carry flap; range of zipped and mesh pockets; range of pouches; elastic fastening grid

Material: Polyester 900d

Size (cm): W 13 x H 23 x D 5

Packing (pcs): 50

Decoration area (cm, HFL® sticker): on HFL® carrier W 5,7 x H 2,3

Decoration possibilities: HALFAR FAST LANE®



black (1)



black (1)

beige (198)



1818067 **SHIFT** LAPTOP SLEEVE

elegant laptop sleeve made of recycled fabric; padded main compartment; padded flap with hook-and-loop fastener; large front pocket with zipper; inner AirTag compartment; back loops for attaching individual accessories, e.g. shoulder strap (not included); ergonomic rear handle, also suitable for fastening to trolley bar; flat side handle for easy lifting, e. g. from backpacks

Material: rPET 300d

Size (cm): W 40 x H 29,5 x D 3,5

Packing (pcs): 25

Decoration area (cm, transfer print): on front pocket W 25 x H 17

Decoration possibilities: silkscreen print; transfer print; embroidery; digitally printed label; doming; metal emblem

horizontal handle, also suitable for trolley attachment



side handle





black-grey sprinkle (740)



black-grey sprinkle (740)

**1814028 ELEGANCE****ZIPPER BAG**

appealing, bicoloured zipper pocket in practical format

Material: Polyester 300d melange

Size (cm): W 28 x H 18

Packing (pcs): 100

Decoration area (cm, silkscreen): on the front W 16 x H 9

Decoration possibilities: silkscreen print; embroidery; transfer print; doming; digitally printed label; metal emblem

**1814027 ELEGANCE****CASE**

zipper main compartment; side handle, handle straps for easy opening and closing

Material: Polyester 300d melange

Size (cm): W 20 x H 7 x D 6

Packing (pcs): 100

Decoration area (cm, silkscreen): on the front W 14 x H 4

Decoration possibilities: silkscreen print; embroidery; transfer print; doming; digitally printed label; metal emblem

SPORTS AND TRAVEL BAGS





green (223)



1818033 DAILY WEEKENDER

modern, lightly padded weekender; rPET outer material; large main compartment with 2-way zip; zipped front pocket; flat zipped compartment inside; adjustable shoulder strap on both sides with sewn shoulder pad; handles with press stud cuff

Material: rPET 600d

Size (cm): W 50 x H 38 x D 20

Packing (pcs): 20

Decoration area (cm, silkscreen): on front pocket W 35 x H 20

Decoration possibilities: silkscreen print; embroidery; transfer print; digitally printed label; metal emblem



anthracite (10)



black (1)



navy (3)



green (223)



red (5)



new



navy (3)



1818070 **SOLID** SPORT/TRAVELBAG

comfortable sports and travel bag with backpack function; recycled outer fabric; large main compartment with 2-way zipper opening; side zipper pocket including shoe bag; front: large front pocket with 2-way zipper opening plus flat zip pocket; inside: hanging zip organizer and spacious zip lid pocket; padded bottom; mesh side pocket for storing the adjustable, removable and padded shoulder straps – ergonomically shaped and usable either as backpack or shoulder strap; carrying handles with padded grip cuff

Material: rPET 900d
Size (cm): W 55 x H 27 x D 27
Packing (pcs): 10

Decoration area (cm, transfer print): on the front pocket W 28 x H 9

Decoration possibilities: silkscreen print; embroidery; transfer print; digitally printed label; doming; metal emblem



black (1)

navy (3)

beige (198)

green-grey (644)



PROMOTIONAL GIFT
AWARD 2023



pigeon blue (455)



pigeon blue (455)



mustard yellow (742)



black (1)



dark green (44)



1818035 ACTIVE SPORTS/TRAVEL BAG

comfortable sports travel bag with backpack function; spacious main compartment with 2-way zip and side buckles; zipped side pocket; zipped front pocket; all-round functional strap band; various handles; carry handles and concealed, padded and length-adjustable shoulder straps

Material: rPET 600d

Size (cm): W 58 x H 34 x D 34

Packing (pcs): 20

Decoration area (cm, silkscreen): on front pocket W 14 x H 20

Decoration possibilities: silkscreen print; transfer print; embroidery; metal emblem

loop for
shoulder strap



anchor-
shaped zip





black (1)



black (1)

anthracite (10)

blue (155)

navy (3)

red (5)



1818037 OUTDOOR SPORTS BAG

lightweight, functional sports bag with backpack function; spacious main compartment; large opening with 2-way zip; zipped pocket in the lid; hanging as well as flat zipped pocket inside; zipped pocket on the side; functional strap band; handles on both sides; adjustable carrying handles can also be used as backpack straps; decorative reflective print

Material: rPET ripstop

Size (cm): W 45 x H 27 x D 27

Packing (pcs): 20

Decoration area (cm, silkscreen): on the front W 15 x H 12,5

Decoration possibilities: silkscreen print; transfer print; embroidery; digitally printed label; metal emblem; doming

length-adjustable carrying handles



handles on both sides





cyan (652)

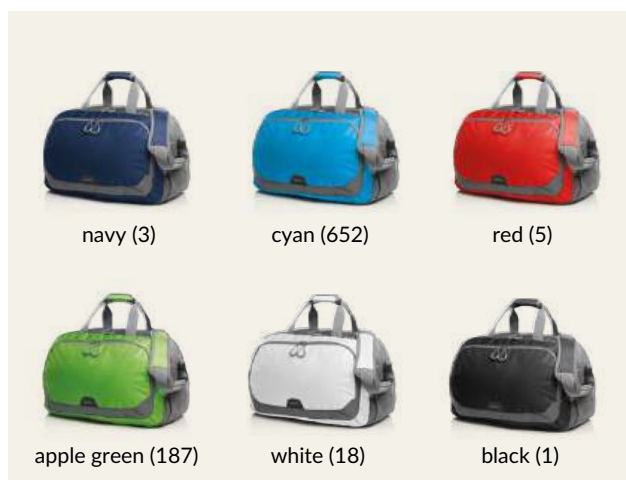

1813342 **STEP** SPORT/TRAVELBAG

spacious zipper main compartment with organizer features and firm inside base; zipper front pocket with reflective element; lateral mesh pouches; lateral shoe compartment; handles with padded grips; removable, length-adjustable shoulder strap

Material: Polyester 420d & ripstop

Size (cm): W 48 x H 33 x D 22

Packing (pcs): 20

Decoration area (cm, silkscreen): on front pocket W 32 x H 13

Decoration possibilities: silkscreen print; transfer print; embroidery; digitally printed label



extra shoe compartment





white (18)



navy (3)



red (5)

orange (169)

apple green (187)

fuchsia (307)

light blue (170)

white (18)



navy (3)

black (1)



1807544 CANNY SPORTS BAG

spacious main compartment with contrast zipper and straps

Material: Polyester 210d

Size (cm): W 52 x H 23 x D 23

Packing (pcs): 50

Decoration area (cm, silkscreen): on the front W 17 x H 11

Decoration possibilities: silkscreen print; transfer print

1814007 SOLUTION SHOE BAG

main compartment with 2-way zipper and decorative ventilation eyelets; carry handle loop

Material: Polyester 600d

Size (cm): W 21 x H 38 x D 15

Packing (pcs): 50

Decoration area (cm, silkscreen): on the front W 15 x H 30; on the side W 8 x H 15

Decoration possibilities: silkscreen print; embroidery; transfer print; doming; digitally printed label; metal emblem



black (1)



black (1)



1801676 **SPORT** SPORT/TRAVELBAG

spacious main compartment with two straps to secure the content; side pockets with decorative mesh and cord trimming; spacious zipper front pocket; detachable and adjustable shoulder strap with shoulder pad

Material: Nylon 420d

Size (cm): W 57 x H 30 x D 28

Packing (pcs): 20

Decoration area (cm, silkscreen): on front pocket W 31 x H 14,5
 Decoration possibilities: silkscreen print; transfer print; embroidery; digitally printed label; metal emblem; doming





red (5)



red (5)

royal blue (8)

navy (3)

black (1)



1815022 TEAM SPORT/TRAVELBAG

classic sports and leisure bag with sturdy bottom tray that can be filled separately; large main compartment with 2-way zipper; firm bottom with base feet; inner zipper compartment; two side pockets with zipper; carrying handles with handle cuff; removable, length-adjustable shoulder strap with shoulder padding

Material: Polyester 600d
Size (cm): W 55 x H 36 x D 30
Packing (pcs): 10

Decoration area (cm, silkscreen): on the front W 32 x H 16
Decoration possibilities: silkscreen print; embroidery; transfer print; doming; digitally printed label; metal emblem





grey sprinkle (638)



blue-grey sprinkle (722)



1814006 CRAFT MULTI BAG

convenient sports-travel bag with backpack function; spacious main compartment with 2-way zipper; large side / cover flap compartment with 2-way zipper and additional flat zipper compartment; side handles with grip cuffs; length-adjustable, detachable shoulder strap with stitched shoulder pad; concealed, padded and length-adjustable backpack straps; handles

Material: Polyester 300d melange
Size (cm): W 52/57 x H 30 x D 32
Packing (pcs): 10

Decoration area (cm, silkscreen): on the front W 16 x H 20,5
Decoration possibilities: silkscreen print; embroidery; transfer print; digitally printed label; metal emblem



1814017 FASHION TRAVEL BAG

spacious 2-way zipper main compartment with solid base insert and flat inside compartment; three front zipper pockets; detachable, length-adjust-able shoulder strap with shoulder pad; handles

Material: Polyester 300d sprinkle
Size (cm): W 52,5 x H 35,5 x D 22,5
Packing (pcs): 25

Decoration area (cm, silkscreen): on front pocket W 26 x H 11
Decoration possibilities: silkscreen print; embroidery; transfer print; digitally printed label; metal emblem



anthracite (10)

- 30 l**
- cotton
- PVC free
- serial
- IATA

1816073 COUNTRY SPORT/TRAVELBAG

spacious zipped main compartment with padded base; large zipped front pocket; removable, adjustable shoulder strap; handles with sleeves

Material: cotton 16 OZ (~453 g/m²)
 Size (cm): W 50 x H 31 x D 20
 Packing (pcs): 25
 Decoration area (cm, silkscreen): on front pocket W 32 x H 13
 Decoration possibilities: silkscreen print; embroidery; transfer print; digitally printed label; metal emblem



anthracite (10)



light-grey sprinkle (728)



1816518 EUROPE SPORT/TRAVELBAG

spacious main compartment with 2-way zip; solid base; rPET outer material; high-quality metal accessories; spacious, hanging inner pocket with zip; detachable, length-adjustable shoulder strap; handles

Material: rPET 600d

Size (cm): W 55/75 x H 45 x D 25

Packing (pcs): 20

Decoration area (cm, silkscreen): on the front W 36 x H 25

Decoration possibilities: silkscreen print; embroidery; transfer print; digitally printed label; metal emblem





grey (54)



1816069 **LOOM**
SPORT/TRAVELBAG

spacious main compartment with two-way zip, padded base and zipped inside pocket; zipped pocket on back; high-quality metal accessories; range of carrying options thanks to removable, adjustable shoulder strap, adjustable handles and press stud attachments on side

Material: cotton/Polyester
Size (cm): W 52/69 x H 28 x D 26
Packing (pcs): 10

Decoration area (cm, silkscreen): on the front W 33 x H 20
Decoration possibilities: silkscreen print; embroidery; transfer print; digitally printed label; metal emblem



grey (54)

nature (704)



black (1)



black (1)



1815003 **COMMUNITY** TRAVEL BAG

classically elegant travel bag with high-quality metal accessories; main compartment with 2-way zipper; inner zipped compartment; three flat slip-in pockets; three pen-holder loops; flat front pocket with magnetic closure; handles; reinforced bottom; detachable, length-adjustable shoulder strap

Material: pu artificial leather

Size (cm): W 56 x H 34 x D 24

Packing (pcs): 10

Decoration area (cm, silkscreen): on front pocket W 23 x H 13

Decoration possibilities: silkscreen print; embroidery; metal emblem



yellow (4)



1818060 PURE
SPORT/TRAVEL BAG

modern sports/travel bag; main compartment with water-repellent 2-way zipper; front pocket with water-repellent zipper; compression carabiner on the side for volume expansion; large zippered compartment inside; trolley attachment on the back; handles with padded grips; detachable, adjustable shoulder strap with sewn shoulder padding

Material: rPET soft PU
 Size (cm): W 48 x H 39 x D 25
 Packing (pcs): 10
 Decoration area (cm, silkscreen): on front pocket W 14 x H 16
 Decoration possibilities: silkscreen print; embroidery; transfer print; metal emblem; digitally printed label; doming

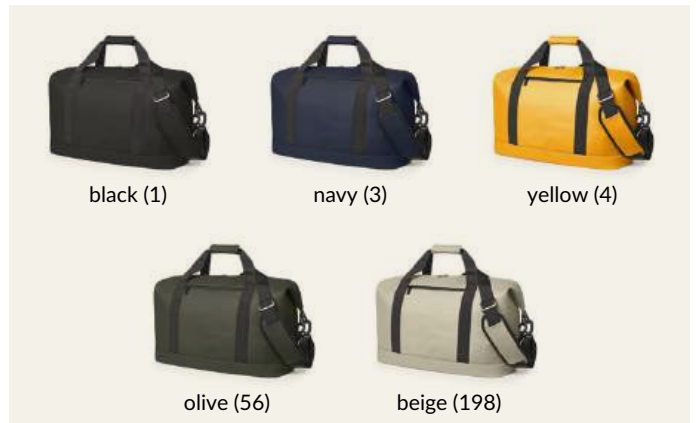

**HALFAR
FAST
LANE®**



black-grey sprinkle (740)



fastening loop
for trolley



1816054 **FRAME** SPORT/TRAVELBAG

large, padded zipped main compartment with attractive quilting; easy to load thanks to press stud attachments on side; zipped mesh compartment and mesh pouches inside; large padded zipped compartment on back; trolley holder; padded base; removable, adjustable shoulder strap with sewn shoulder pad; two padded handles

Material: Polyester 900d

Size (cm): W 51 x H 30 x D 23

Packing (pcs): 10

Decoration area (cm, HFL® sticker): on HFL® carrier W 5,7 x H 2,3

Decoration possibilities: HALFAR FAST LANE®





navy (3)



extra shoe compartment



1809789 MISSION SPORT/TRAVELBAG

spacious main compartment with two-way zipper; two front pockets with zipper; two side pockets with zipper; removable, adjustable shoulder strap with comfortable shoulder pad; handles with grip cuffs; bottom studs

Material: Polyester 1680d
Size (cm): W 66/56 x H 32 x D 25
Packing (pcs): 10

Decoration area (cm, silkscreen): on front pocket W 35 x H 14
Decoration possibilities: silkscreen print; transfer print; embroidery; digitally printed label; metal emblem



black (1)



navy (3)



black (1)



1815010 HASHTAG ROLLER TRAVELBAG

elaborate trolley case with reflex trim; main compartment with two-way zip on three sides; main compartment top with zipped separator; main compartment bottom with elastic packing straps; small zipped front pockets with coloured zip slider; large front pocket with two-way zip, flat, padded pouch, two small pouches, large mesh zipped pocket and elastic loops; padded handles; reinforced base; base feet; telescopic handle; easy-roll wheels

Material: Polyester 1680d
Size (cm): W 35 x H 65 x D 28
Packing (pcs): 4

Decoration area (cm, silkscreen): on lower front pocket
W 23 x H 28

Decoration possibilities: silkscreen print; embroidery; doming; metal emblem





black (1)

smooth running wheels



removable shoulder strap



padded handle



72 l serial

1813347 IMPULSE ROLLER TRAVELBAG

spacious zipper main compartment; zipper front pocket with decorative backstitching; telescopic pole; lightweight rollers; handles with padded grips; removable, length-adjustable shoulder strap with shoulder pad

Material: Polyester 1680d
 Size (cm): W 66 x H 32 x D 35
 Packing (pcs): 4
 Decoration area (cm, transfer print): on the lid W 30 x H 27
 Decoration possibilities: transfer print; embroidery; digitally printed label; metal emblem

COSMETICS AND TOILET BAGS





green-grey (644)



1818051 FLEX
WASH BAG

attractive hanging or standing toiletry bag; recycled outer fabric; zippered front pocket; front loop strap; three-sided 2-way zipper; zippered pocket in lid; four mesh pockets inside; handle

Material: rPET 600d
 Size (cm): W 23 x H 24 x D 10,5
 Packing (pcs): 50
 Decoration area (cm, silkscreen): on front pocket W 13 x H 8
 Decoration possibilities: silkscreen print; embroidery; transfer print; metal emblem; digitally printed label; doming



black (1)

navy (3)

anthracite (10)

beige (198)

green-grey (644)



mustard yellow (742)



1818040 **ACTIVE** WASH BAG

elaborately crafted and padded; to stand up or hang; zipped lid compartment; functional loop strap inside and outside; two mesh pockets and a flat zipped pocket inside; handle

Material: rPET 600d
 Size (cm): W 28 x H 15 x D 15
 Packing (pcs): 25
 Decoration area (cm, silkscreen): on the lid W 12 x H 8
 Decoration possibilities: silkscreen print; transfer print; digitally printed label; Metal emblem



pigeon blue (455)



mustard yellow (742)



black (1)



dark green (44)



green sprinkle (717)

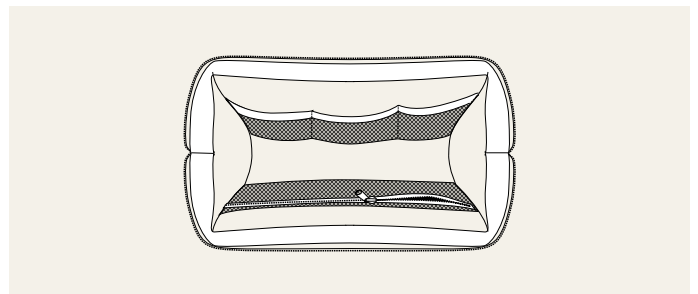

1816500 CIRCLE
ZIPPER BAG

stylish zip pocket bag with sturdy metal hoop opening for upright standing or hanging; rPET outer material; large, padded main compartment, with various organiser elements; front pocket with zip; handle

Material: rPET 300d melange
Size (cm): W 26 x H 18 x D 14
Packing (pcs): 50

Decoration area (cm, silkscreen): on front pocket W 19 x H 9
Decoration possibilities: silkscreen print; transfer print; embroidery; digitally printed label; metal emblem; doming



light-grey sprinkle (728)

blue-grey sprinkle (722)

black sprinkle (678)

green sprinkle (717)



black-grey sprinkle (740)



black-grey sprinkle (740)



1816055 FRAME ZIPPER BAG

functional, padded zip pocket with elaborately-stitched front and HFL®-carrier for your logo; main compartment with flat zip mesh pocket and two mesh pockets; back, flat zippered pocket on the back; hand grip

Material: Polyester 900d

Size (cm): W 24 x H 17 x D 9

Packing (pcs): 25

Decoration area (cm, HFL®-sticker): on HFL® carrier W 5,7 x H 2,3

Decoration possibilities: HALFAR FAST LANE®



black (1)



black (1)

anthracite (10)

navy (3)

green (223)



1818021 DAILY ZIPPER BAG

practical rectangular-shaped zipped bag for many uses; rPET outer material; large 2-way zipped main compartment; mesh pocket inside; side grip tabs for easy opening; handle

Material: rPET 600d

Size (cm): W 22 x H 12 x D 10

Packing (pcs): 100

Decoration area (cm, silkscreen): on the front W 16 x H 7

Decoration possibilities: silkscreen print; embroidery; transfer print; digitally printed label; metal emblem



black (1)



black (1)



black (1)



1802719 **SPORT** WASH BAG

for hanging; with various compartments

Material: Nylon 420d
 Size (cm): W 27 x H 20/52
 Packing (pcs): 50
 Decoration area (cm, silkscreen): on the flap W 10 x H 6
 Decoration possibilities: silkscreen print; transfer print; embroidery; metal emblem

1801059 **BUSINESS** WASH BAG

spacious padded main compartment; three zipper pockets; metal hook for hanging; handle

Material: Polyester 600d
 Size (cm): W 27 x H 16 x D 12
 Packing (pcs): 25
 Decoration area (cm, silkscreen): on the lid, only one colour W 12 x H 10; on the front W 8 x H 4
 Decoration possibilities: silkscreen print; transfer print; embroidery; digitally printed label; metal emblem; doming



transparent (6)



transparent (6)



1800177 **UNIVERSAL** ZIPPER BAG

trimming in grey

Material: transparent foil 0.25 mm

Size (cm): W 27 x H 17 x D 7

Packing (pcs): 250

Decoration area (cm, silkscreen): on the front, only one colour
W 15 x H 8

Decoration possibilities: silkscreen print



transparent (6)



transparent (6)



1800772 **UNIVERSAL** BAG WITH PRESS BUTTONS

metal press buttons

Material: transparent foil 0.25 mm

Size (cm): W 19 x H 11,5 x D 6,5

Packing (pcs): 250

Decoration area (cm, silkscreen): on the front, only one colour
W 11 x H 2,5

Decoration possibilities: silkscreen print



apple green (187)



navy (3)



cyan (652)

navy (3)

apple green (187)

black (1)

red (5)

white (18)



navy (3)

anthracite (10)

white (18)

1813059 SWITCH ZIPPER BAG

main compartment with wrist strap; silver zipper; insert pouch on the inside

Material: Polyester 600d

Size (cm): W 23 x H 8,5 x D 17,5

Decoration area (cm, silkscreen): on the lid W 17 x H 12

Packing (pcs): 50

Decoration possibilities: silkscreen print; transfer print; embroidery; digitally printed label; metal emblem; doming



1807546 COLLECT ZIPPER BAG

main compartment with silver coloured zipper

Material: Polyester 600d

Size (cm): W 18 x H 12 x D 4

Packing (pcs): 250

Decoration area (cm, silkscreen): on the front W 12 x H 8

Decoration possibilities: silkscreen print; transfer print; embroidery; digitally printed label; metal emblem

ORGANIC
COTTON

nature (704)



ORGANIC M



ORGANIC S

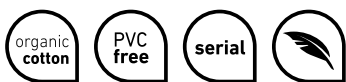

1814012 ORGANIC M ZIPPER BAG

high-quality, heavy-weight organic cotton;
main compartment with zipper

Material: organic cotton 10 OZ (~283 g/m²)
Size (cm): W 25 x H 14 x D 6
Packing (pcs): 250
Decoration area (cm, silkscreen Basic):
on the front W 16 x H 10
Decoration possibilities: silkscreen Basic
print; embroidery; transfer print; digitally
printed label

1814011 ORGANIC S ZIPPER BAG

high-quality, heavy-weight organic cotton;
main compartment with zipper

Material: organic cotton 10 OZ (~283 g/m²)
Size (cm): W 20 x H 12 x D 4
Packing (pcs): 250
Decoration area (cm, silkscreenBasic):
on the front W 11 x H 8
Decoration possibilities: silkscreen Basic
print; transfer print



ORGANIC
COTTON



nature (704)



1815021 ORGANIC CASE

universally applicable bag with drawstring closure; three flat compartments inside; carrying loop

Material: organic cotton 10 OZ (~312 g/m²)

Size (cm): Ø 17 x H 23

Packing (pcs): 50

Decoration area (cm, silkscreen Basic): on the front W 17 x H 13

Decoration possibilities: silkscreen Basic print; embroidery; metal emblem; transfer print; digitally printed label



nature (704)

SHOPPING BAGS AND BASKETS



MONO
 JUST 1 MATERIAL
 100% RECYCABLE

ORGANIC
 COTTON

new



navy (3)



1818042 ORGANIC CASUAL SHOPPER

high-quality mono-material shopper made of organic cotton with extra soft handtouch; hanging organizer inside; short handles and long shoulder straps

Material: Bio-cotton 8 OZ (~227 g/m²)

Size (cm): W 33 x H 41 x D 13,5

Packing (pcs): 50

Decoration area (cm, silkscreen print): on the front W 32 x H 31

Decoration possibilities: silkscreen print; transfer print; embroidery; digitally printed label; doming; metal emblem



black (1)

navy (3)

nature (704)

dusky pink (450)

green-grey (644)



orange (169)



1816507 **SUNNY** SHOPPER

beautifully shaped, large shopper; spacious main compartment; attractive round handles with a pleasant feel

Material: cotton 10 OZ (~284 g/m²)

Size (cm): W 52 x H 45 x D 17

Packing (pcs): 25

Decoration area (cm, silkscreen): on the front W 30 x H 16

Decoration possibilities: silkscreen print; transfer print; embroidery; digitally printed label; metal emblem



orange (169)



nature (704)



khaki (739)

ORGANIC COTTON

new



nature (704)



MONO
JUST 1 MATERIAL
100% RECYCLABLE



1818066 ORGANIC WELLNESS SHOPPER BAG

mono-material wellness shopper made of heavy organic cotton; side tabs for attaching objects, e.g. pendants, carabiners, etc.; four side pockets on the outside; hanging organizer with envelope closure inside; stable circumferential shoulder straps

Material: Bio-cotton 11 OZ (~312 g/m²)
 Size (cm): W 35 x H 40 x D 18
 Packing (pcs): 25
 Decoration area (cm, silkscreen print): on the front between straps W 10 x H 28
 Decoration possibilities: silkscreen print; transfer print; embroidery; digitally printed label; doming; metal emblem



medium grey (115)

nature (704)





red (5)



1814023 BEACH SHOPPER

very large cotton shopper, heavy quality; generous cut with large front pocket; hook and loop tape closure; contemporary block stripe design

Material: cotton 11 OZ (~312 g/m²)

Size (cm): W 60/42 x H 46 x D 18

Packing (pcs): 25

Decoration area (cm, silkscreen): on front pocket W 23 x H 20

Decoration possibilities: silkscreen print; transfer print; embroidery; digitally printed label; metal emblem



anthracite (10)



navy (3)



red (5)



orange (169)

COTTON
+ JUTE



nature (704)



1814003 **NATIVE** SHOPPER

robust shopper; generously-sized, deep design; organiser with zipper

Material: jute/cotton

Size (cm): W 40 x H 40 x D 15

Packing (pcs): 50

Decoration area (cm, silkscreen): on the front W 31 x H 13

Decoration possibilities: silkscreen print; embroidery; transfer print; digitally printed label; metal emblem





nature (704)



1815020 FAIR SHOPPER

stylish, practical carrying bag made of sturdy cotton; long handles

Material: cotton 5 OZ (~142 g/m²)

Size (cm): W 38 x H 42

Packing (pcs): 100

Decoration area (cm, silkscreen Basic): on the front W 28 x H 33

Decoration possibilities: silkscreen Basic print; embroidery; transfer print; digitally printed label



ORGANIC
COTTON

nature (704)

new



1818041 ORGANIC DRAWSTRING TOTE BAG

practical mono-material shopper made of organic cotton with drawstring closure; hanging organizer inside; short handle; long carrying strap

Material: Bio-cotton 5 OZ (~142 g/m²)

Size (cm): W 35 x H 45

Packing (pcs): 100

Decoration area (cm, silkscreen print): on the front W 27 x H 35

Decoration possibilities: silkscreen print; transfer print; embroidery; digitally printed label; doming; metal emblem

MONO
JUST 1 MATERIAL
100% RECYCABLE



ORGANIC
COTTON

nature (704)

ORGANIC
COTTON

nature (704)



1815021 ORGANIC CASE

universally applicable bag with drawstring closure; three flat compartments inside; carrying loop

Material: organic cotton 10 OZ (~312 g/m²)

Size (cm): Ø 17 x H 23

Packing (pcs): 50

Decoration area (cm, silkscreen Basic): on the front W 17 x H 13

Decoration possibilities: silkscreen Basic print; embroidery; metal emblem; transfer print; digitally printed label



1816061 ORGANIC REUSABLE PRODUCE BAG

reusable multi-purpose bag with drawstring closure

Material: organic cotton 5 OZ (~142 g/m²)

Size (cm): W 30 x H 40

Packing (pcs): 250

Decoration area (cm, silkscreen Basic): on the front W 21 x H 6

Decoration possibilities: silkscreen Basic print; transfer print



ORGANIC COTTON



1809799 ORGANIC SHOPPER

premium, heavy weight organic cotton bag; generous cut with plenty of depth

Material: organic cotton 10 OZ (~283 g/m²)

Size (cm): W 36 x H 40 x D 10

Packing (pcs): 50

Decoration area (cm, silkscreen Basic): on the front W 28 x H 30

Decoration possibilities: silkscreen Basic print; transfer print; embroidery; digitally printed label; metal emblem



navy (3)



1815014 EARTH SHOPPER

stylish, practical carrying bag made of sturdy cotton; long handles

Material: cotton 5 OZ (~142 g/m²)

Size (cm): W 38 x H 42

Packing (pcs): 250

Decoration area (cm, silkscreen Basic): on the front W 28 x H 33

Decoration possibilities: silkscreen Basic print; transfer print; embroidery; digitally printed label; metal emblem



white (18)



black (1)



apple green (187)



navy (3)



red (5)



anthracite (10)



**1809798 MALL
SHOPPER**

quality, heavy weight cotton bag; modern cut

Material: cotton 10 OZ (~283 g/m²)

Size (cm): W 34 x H 37 x D 0/13

Packing (pcs): 100

Decoration area (cm, silkscreen Basic): on the front W 25 x H 27

Decoration possibilities: silkscreen Basic print; transfer print; embroidery; digitally printed label; metal emblem



white (18)



anthracite (10)



navy (3)



red (5)



beige (22)



1816062 PLANET SHOPPER

streamlined shopper made from pre-recycled cotton; long handles

Material: pre-recycled cotton 5 OZ (~142 g/m²)

Size (cm): W 38 x H 42

Packing (pcs): 250

Decoration area (cm, silkscreen Basic): on the front W 28 x H 31

Decoration possibilities: silkscreen Basic; embroidery; transfer print; digitally printed label



blue (155)

beige (22)



light grey (145)



red (215)



1816065 PLANET
TOTE BAG



streamlined tote bag made from pre-recycled cotton; ideal for A4 documents; long shoulder strap

Material: pre-recycled cotton 5 OZ (~142 g/m²)
 Size (cm): W 28 x H 36
 Packing (pcs): 250
 Decoration area (cm, silkscreen Basic): on the front W 19,5 x H 27
 Decoration possibilities: silkscreen Basic; embroidery; transfer print; digitally printed label



blue (155)

beige (22)

red (215)

light grey (145)



red (5)



1807785 **BONNY** SHOPPER

nicely shaped, big shopper with decorative eyelet ring and cord straps; main compartment with hanging organizer

Material: Polyester 600d
Size (cm): W 46/60 x H 40 x D 14
Packing (pcs): 20

Decoration area (cm, silkscreen): on the front W 25 x H 18
Decoration possibilities: silkscreen print; transfer print; embroidery; digitally printed label; metal emblem



apple green (187)



1807781 **SOLUTION** SHOPPER

nicely shaped, big shopper with decorative metal buckle and two-tone straps; main compartment with hanging zip organizer

Material: Polyester 600d
Size (cm): W 40 x H 43 x D 16
Packing (pcs): 25

Decoration area (cm, silkscreen): on the front W 30 x H 23
Decoration possibilities: silkscreen print; transfer print; embroidery; digitally printed label; metal emblem



black (1)



can be folded together



1814016 STORE SHOPPER

elegant shopper; main compartment closable via zipper; inner bag, folding and storage function

Material: Polyester 420d ripstop

Size (cm): W 50 x H 35 x D 15

Packing (pcs): 100

Decoration area (cm, silkscreen): on the front W 31 x H 25

Decoration possibilities: silkscreen print; embroidery; transfer print; doming





grey (54)



1816070 **LOOM** SHOPPER

sturdy shopper with zipped main compartment; zipped inside pocket; zipped pocket on back

Material: cotton/Polyester

Size (cm): W 44 x H 45 x D 16

Packing (pcs): 20

Decoration area (cm, silkscreen): on the front W 28 x H 32,5
 Decoration possibilities: silkscreen print; embroidery; transfer print; digitally printed label; metal emblem



nature (704)



grey (54)



zipped pocket



grey-brown (309)



1816519 LIFE SHOPPER

modern, elaborately crafted shopper; lovingly designed with high-quality metal accessories and coated cotton trims; large main compartment closed by zipper and press stud; hanging zipper inner pocket; zipper pocket accessible on the side from the outside; long carrying handles; adjustable, detachable cotton shoulder strap

Material: cotton 12 OZ (~340 g/m²)

Size (cm): W 29/44 x H 45 x D 16

Packing (pcs): 25

Decoration area (cm, silkscreen): on the front W 22 x H 18

Decoration possibilities: silkscreen print; transfer print; embroidery; digitally printed label; metal emblem



grey-brown (309)



navy-brown (308)



black-black (60)



black (1)

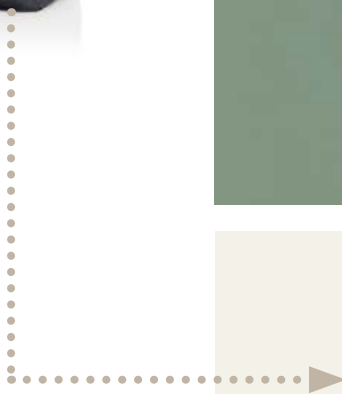

can be folded together

1815017 SKY SHOPPER

large shopper; spacious main compartment with zipper; front zipper pocket; inside zipper pocket; long carrying handles; folding and stowing function

Material: Polyester 300d sprinkle
 Size (cm): W 40/55 x H 40 x D 15
 Packing (pcs): 50

Decoration area (cm, silkscreen): on the front W 23 x H 8
 Decoration possibilities: silkscreen print; embroidery; doming; metal emblem; transfer print; digitally printed label



apple green (187)



black (1)



blue (155)



navy (3)



red (215)



light grey (145)



grey (54)



1818023 BIG SHOPPER

beautifully designed, extra large shopper; main compartment with hanging zipped organizer; carrying system with double handles

Material: Polyester 1080d two tone

Size (cm): W 50/70 x H 50 x D 20

Packing (pcs): 25

Decoration area (cm, silkscreen): on the front W 33 x H 37

Decoration possibilities: silkscreen print; embroidery; doming; metal emblem; transfer print; digitally printed label

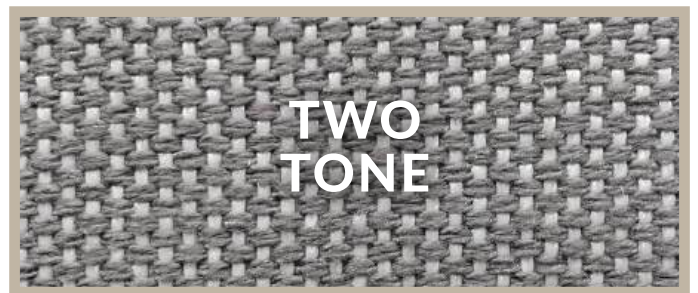

grey (54)



green sprinkle (717)



1816078 **CIRCLE** SHOPPER

urban shopper with zipped main compartment; rPET upper material; padded base; zipped outer pocket; two carry handles

Material: rPET 300d

Size (cm): W 30 x H 44 x D 16

Packing (pcs): 50

Decoration area (cm, silkscreen): on the front pocket W 28 x H 26

Decoration possibilities: silkscreen print; embroidery; transfer print; digitally printed label; metal emblem



green sprinkle (717)



blue-grey sprinkle (722)



black sprinkle (678)



light-grey sprinkle (728)



green (223)



1818019 DAILY SHOPPER

beautifully designed, large shopper; rPET upper material; main compartment with hanging zipped organiser; carrying system with double handles and decorative buckle

Material: rPET 600d
 Size (cm): W 40 x H 43 x D 16
 Packing (pcs): 25

Decoration area (cm, silkscreen): on the front W 28 x H 27
 Decoration possibilities: silkscreen print; embroidery; transfer print; digitally printed label; metal emblem



black (1)

anthracite (10)



green (223)

red (5)

navy (3)



anthracite (10)



anthracite (10)



1814000 JERSEY SHOPPER

stylish, practical shopper made from fine jersey material which is pleasant to the touch; closable with a zipper; long handles

Material: Polyester Jersey
 Size (cm): W 31/45 x H 40 x D 15
 Packing (pcs): 50
 Decoration area (cm, silkscreen): on the front W 28 x H 26
 Decoration possibilities: silkscreen print; transfer print; doming



anthracite (10)

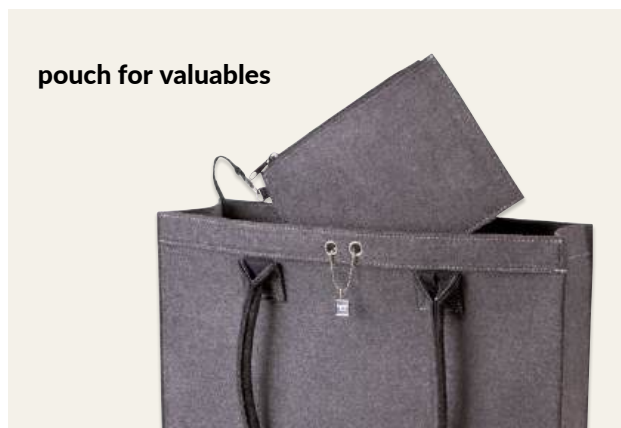

1807556 MODERNCLASSIC CITY SHOPPER

premium felt shopper; removable zipper pouch for valuables

Material: recycled PES felt
 Size (cm): W 37 x H 30 x D 12
 Packing (pcs): 25
 Decoration area (cm, embroidery): on the front W 16 x H 14,5
 Decoration possibilities: embroidery; transfer print; digitally printed label; metal emblem; doming



anthracite (10)



anthracite (10)



navy (3)



anthracite (10)



1818024 INLAY
187



1805710 NEWCLASSIC SHOPPER

premium felt shopper; inside organizer with zipper; loose inlay bottom

Material: recycled PES felt
 Size (cm): W 26/45 x H 40 x D 14
 Packing (pcs): 25
 Decoration area (cm, embroidery): on the front W 29 x H 16
 Decoration possibilities: embroidery; transfer print; digitally printed label; metal emblem



1818031 SOFTBASKET FELT SHOPPER

flexible, spacious shopper for a range of uses; large main compartment with base feet; zipped front pocket; carrying system with double handles and padded handle cuff for best carrying comfort

Material: recycled PES felt
 Size (cm): W 40/44 x H 37 x D 20
 Packing (pcs): 25
 Decoration area (cm, embroidery): on the front pocket W 16 x H 16
 Decoration possibilities: embroidery; transfer print; digitally printed label; metal emblem



MONO

JUST 1 MATERIAL
100% RECYCABLE



offwhite (222)



1818055 MONO SHOPPER

innovative knitted shopper; attractive tile look: mono material; large main compartment with hanging organiser; ergonomically designed shoulder straps

Material: Polyester
 Size (cm): W 36 x H 36 x D 18
 Packing (pcs): 25
 Decoration area (cm, embroidery): on the front W 28,5 x H 10
 Decoration possibilities: embroidery; transfer print; metal emblem







beige (198)



1818020 SOFTBASKET SHOPPER

flexible, spacious shopper for a range of uses; large main compartment with base feet; zipped front pocket; carrying system with double handles and padded handle cuff for best carrying comfort

Material: rPET 600d
 Size (cm): W 40/44 x H 37 x D 20
 Packing (pcs): 25

Decoration area (cm, silkscreen): on front pocket W 27 x H 20
 Decoration possibilities: silkscreen print; transfer print; embroidery; digitally printed label; metal emblem; doming





PVC
free

RECYCLED
PET 





olive (56)



anthracite (10)



medium grey (115) beige (198) olive (56) black (1)



anthracite (10)



1807777 BLACKBASKET SHOPPER

nically designed shopping basket with aluminium frame and zipper front pocket; foldable

Material: rPET 600d
 Size (cm): W 45 x H 25/45 x D 25
 Packing (pcs): 10
 Decoration area (cm, silkscreen): on front pocket W 25 x H 10
 Decoration possibilities: silkscreen print; transfer print; embroidery; digitally printed label; metal emblem; doming



1808800 BASKET FELT SHOPPER

nically designed felt basket with aluminium frame and zipper front pocket; foldable

Material: recycled PES felt
 Size (cm): W 45 x H 25/45 x D 25
 Packing (pcs): 10
 Decoration area (cm, embroidery): on front pocket W 12 x H 7
 Decoration possibilities: embroidery; transfer print; digitally printed label; metal emblem; doming



light green (306)



1818024 INLAY

 187

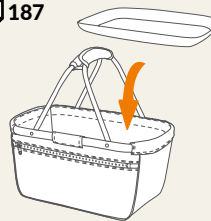

1803939 BASKET SHOPPER

nicely designed shopping basket with aluminium frame and zipper front pocket; foldable

Material: rPET 600d

Size (cm): W 45 x H 25/45 x D 25

Packing (pcs): 10

Decoration area (cm, silkscreen): on front pocket W 25 x H 10
 Decoration possibilities: silkscreen print; transfer print; embroidery; digitally printed label; metal emblem; doming



black (1)



navy (3)



red (5)



royal blue (8)



anthracite (10)



orange (169)



light green (306)



lilac (789)



anthracite (10)



1818024 BASKET INLAY

practical inlay for the models in the (SOFT)BASKET series;
protects against dirt in the base: raised edge for catching drops
of water

Material: recycled PES felt
Size (cm): W 40,5 x H 3 x D 24
Packing (pcs): 50



COOLER BAGS





jade green (19)



1818049 **SOFTBASKET** LUNCHBAG

stylish cooling bag; main compartment with 2-way zipper; generously padded; washable interior; detachable, adjustable strap on one side with rubber flap for strap attachment; D-rings on both sides for attachment of e.g.: optional shoulder strap* or keys; bottom feet; loops on back for attaching to bike handlebars

Material: rPET 600d
Size (cm): W 26 x H 17 x D 15
Packing (pcs): 20

Decoration area (cm, silkscreen): on front pocket W 16 x H 7
Decoration possibilities: silkscreen print; embroidery; transfer print; metal emblem; digitally printed label; doming





anthracite (10)



1818050 **SOFTBASKET** FELT LUNCHBAG

timeless felt cooling bag; main compartment with 2-way zipper; generously padded; washable inside; detachable, length-adjustable strap on one side with G-hook and rubber tab for strap attachment; D-rings on both sides for attachment of optional shoulder strap* or keys for example; bottom feet; loops on back for attaching to bike handlebars

*Not included

Material: recycled PES felt
Size (cm): W 26 x H 17 x D 15
Packing (pcs): 20

Decoration area (cm, silkscreen): on front pocket W 10 x H 5
Decoration possibilities: embroidery; transfer print; metal emblem; digitally printed label; doming





grey sprinkle (638)



1816503 TREND COOLER BACKPACK

large, modern cool backpack; top with two-way zipper on three sides ideal for packing; large main compartment; zipper mesh pocket for cold packs inside; outside top zipper compartment; large front pocket with 2-way zipper; padded back; padded adjustable shoulder straps; handle

Material: Polyester 300d
Size (cm): W 30 x H 42 x D 15
Packing (pcs): 20

Decoration area (cm, silkscreen): on the lid W 17 x H 9; on front pocket W 19 x H 15

Decoration possibilities: silkscreen print; transfer print; embroidery; doming; digitally printed label; metal emblem





white (18)



1802721 SPORT COOL BAG

spacious main compartment; two-way zipper front pocket; mesh side-pockets; clear map compartment on top; removable shoulder strap; straps on back for attaching onto bike

Material: Nylon 420d

Size (cm): W 30 x H 24 x D 18

Packing (pcs): 20

Decoration area (cm, silkscreen): on front pocket W 13 x H 13

Decoration possibilities: silkscreen print; transfer print; embroidery; digitally printed label; metal emblem; doming



map compartment



black (1)

navy (3)

red (5)

white (18)

apple green (187)



red (5)



1815028 FLOW
THERMO BAG

versatile cooling bag; large, padded zipped main compartment; snap closure for various carrying methods

Material: Polyester 600d
Size (cm): W 21/28 x H 27 x D 10
Packing (pcs): 50
Decoration area (cm, transfer print): on the front W 17 x H 8
Decoration possibilities: transfer print; doming



red (5)



apple green (187)



anthracite (10)



black (1)



navy (3)



cyan (652)

HOW
TO ...





apple green (187)



1814015 SOLUTION LUNCHBAG

main compartment with 2-way zipper; flat front pocket; handles

Material: Polyester 600d

Size (cm): W 25,5 x H 16 x D 15

Packing (pcs): 50

Decoration area (cm, silkscreen): on the front pocket W 15 x H 7

Decoration possibilities: silkscreen print; embroidery; transfer print; doming;digitally printed label; metal emblem



red (5)



black (1)



navy (3)



apple green (187)



navy (3)



1809797 SOLUTION
COOL BAG

large main compartment suitable for 5 x 1 litre bottles; flat front pouch; handles; adjustable shoulder strap

Material: Polyester 600d
Size (cm): W 30 x H 31 x D 15
Packing (pcs): 25

Decoration area (cm, silkscreen): on front pocket W 21 x H 14
Decoration possibilities: silkscreen print; transfer print; embroidery; doming; digitally printed label; metal emblem







olive (56)



1818052 BOTTLE THERMO BAG

versatile cooling bag; large, padded zipped main compartment; snap closure for various daytime wearing options, detachable, length-adjustment carrying strap

Material: rPET 600d
 Size (cm): W 17 x H 38 x D 11
 Packing (pcs): 50
 Decoration area (cm, transfer print): on the front W 7,5 x H 20
 Decoration possibilities: transfer print; doming





green (223)



1818017 DAILY COOLER SHOPPER

large cooler shopper; rPET upper material; premium padded zipped main compartment inside washable; large zipped front pocket; handles with decorative buckle

Material: rPET 600d

Size (cm): W 33 x H 40 x D 15

Packing (pcs): 25

Decoration area (cm, silkscreen): on front pocket W 22 x H 20

Decoration possibilities: silkscreen print; transfer print; embroidery; digitally printed label; metal emblem



black (1)

red (5)

anthracite (10)

navy (3)



navy (3)



1815015 BASKET
COOLER SHOPPER

nicey-designed cooling basket with aluminium frame; main zipper compartment; front zipper pocket; magnetic cuff; inside washable; foldable

Material: rPET 600d
 Size (cm): W 45 x H 25/45 x D 25
 Packing (pcs): 10
 Decoration area (cm, silkscreen): on front pocket W 25 x H 10
 Decoration possibilities: silkscreen print; embroidery; transfer print; doming; digitally printed label; metal emblem

keeps fresh ~10 h



red (5)

black (1)

navy (3)



teal (691)



- 22 l
- food grade
-
- PVC free
- serial

1818030 **SOFTBASKET** COOLER SHOPPER

innovative flexible cooler basket; large 2-way zipped main compartment; volume can be increased via side press stud flaps; zipped front pocket; washable inside; carrying system with double handles and padded handle cuff for best carrying comfort; folds up

Material: Polyester 600d
Size (cm): W 41 x H 25 x D 20
Packing (pcs): 10

Decoration area (cm, silkscreen): on front pocket W 25 x H 10
Decoration possibilities: silkscreen print; embroidery; transfer print; doming; digitally printed label; metal emblem

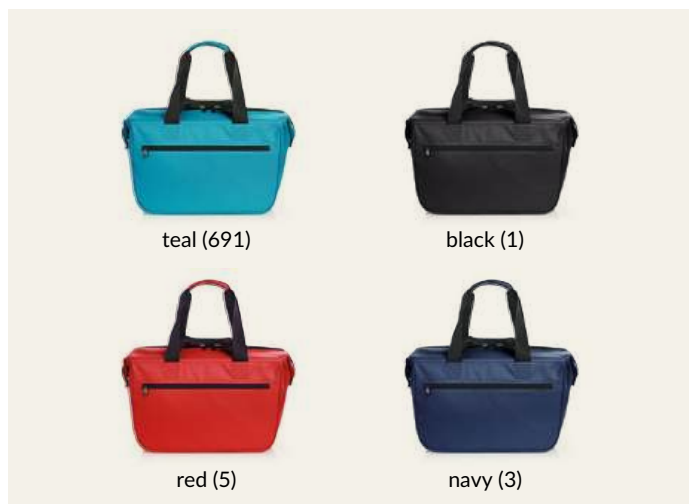

teal (691)

black (1)

red (5)

navy (3)



cyan (652)



1812211 FAMILY XL
COOL BAG

large main compartment with 2-way-zipper; lateral mesh pouches; flat insert pouch at the top

Material: Polyester 600d
Size (cm): W 37 x H 20 x D 27
Packing (pcs): 20

Decoration area (cm, silkscreen): on the lid W 22 x H 15
Decoration possibilities: silkscreen print; transfer print; embroidery; digitally printed label; metal emblem; doming



AS GOOD AS MADE TO MEASURE:

THE HALFAR® MODULAR BAG.



Choose your model.

Messenger bag, writing folder or backpack? In the HALFAR® modular system, you'll find many models that can easily be customised – in colour and material. That's how an idea quickly turns into a unique bag.



By the way: all modular bags – whether Original LorryBag® or modular model – are made in our European production facilities. This ensures quality, flexibility and short supply routes. Feel free to contact us.



Go directly to the inquiry form!



CHOOSE YOUR FAVOURITE COLOUR.

The world is colourful – and so are your possibilities. Whether a flap made of tarpaulin or felt, or a completely multicoloured bag – it's simply a matter of taste.



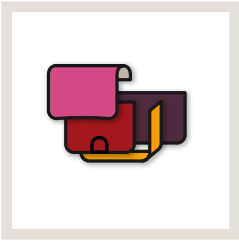

LorryBag® ORIGINAL
From front to back in your colours: with these models, each individual panel can be selected separately from the full colour palette.

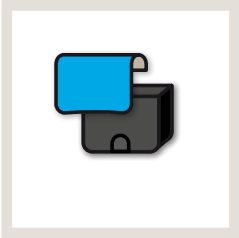

MODUL
Things get colourful with the flap – in exactly the shade you choose. For the bag body, various model versions are available.



FELT COLOURS



TARPAULIN COLOURS

CHOOSE THE MATERIAL.



Tarpaulin and felt are true classics from our range. Would you like to use your own material to create a truly unique bag? Go ahead – we'll be happy to advise you.

Does that work?

Coffee sacks, airbags, bicycle tyres – we've already turned many things into bags. We'll check in advance whether your material can be used for a bag.

TARPAULIN



FAUX FUR



FELT

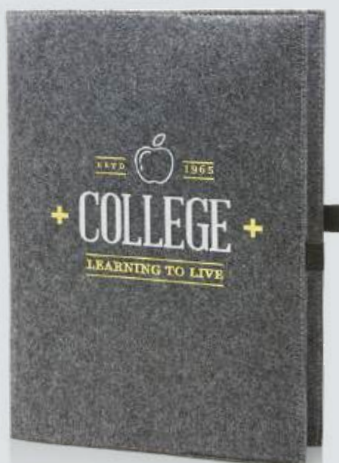

AIRBAG MATERIAL



THE HALFAR®- MODULAR SYSTEM

EVERY PROJECT IS DIFFERENT – AND THAT'S EXACTLY HOW WE APPROACH IT.

Wondering what your individual modular bag will cost? It's easy: **just ask us!**

We'll be happy to make you an attractive offer.

LORRYBAG® ORIGINAL



1109109 ORIGINAL 2 LORRYBAG® NOTEBOOK

main compartment with large, padded flap, notebook compartment, mobile phone pocket with pull-out tab; slip-in pockets; mesh pockets; fixing strap; buckle closure with decorative trim; extra-wide, length-adjustable shoulder strap running around the sides. You choose the colour of the panels (truck tarpaulin included in the price!) or alternative materials at the respective price

Material: tarpaulin

Size (cm): W 36 x H 28 x D 11

Decoration area (cm, digital print): on the flap W 35 x H 31,5

Decoration possibilities: silkscreen print; embroidery; digital print; digitally printed label; metal emblem



1101401 ORIGINAL 1 LORRYBAG®

main compartment with large flap; hook and loop tape fastener; adjustable shoulder strap with shoulder pad. Possible interior features, on application

Material: tarpaulin

Size (cm): W 37 x H 29 x D 13

Decoration area (cm, digital print): on the flap W 35,5 x H 38

Decoration possibilities: silk-screen print; embroidery; digital print; digitally printed label; metal emblem

1101401#H ORIGINAL 1 H LORRYBAG®

Material: tarpaulin

Size (cm): W 26 x H 34 x D 9

Decoration area (cm, digital print): on the flap W 25 x H 38,5

Decoration possibilities: silk-screen print; embroidery; digital print; digitally printed label; metal emblem



1101401#M ORIGINAL 1 M LORRYBAG®

main compartment with large flap; hook and loop tape fastener; adjustable shoulder strap with shoulder pad. Possible interior features, on application

Material: tarpaulin

Size (cm): W 33 x H 25 x D 9

Decoration area (cm, digital print): on the flap W 32 x H 31

Decoration possibilities: silk-screen print; embroidery; digital print; digitally printed label; metal emblem

1101401#S ORIGINAL 1 S LORRYBAG®

Material: tarpaulin

Size (cm): W 23 x H 25 x D 9,5

Decoration area (cm, digital print): on the flap W 21 x H 31

Decoration possibilities: silk-screen print; embroidery; digital print; digitally printed label; metal emblem

MODUL



1809110 MODUL 2 LORRYBAG® NOTEBOOK

main compartment with big flap, notebook compartment, mobile pouch, inside pockets, elastic fixing strap, mesh pockets, buckle closure. Choose your own flap! The flap is made in your preferred colour (tarpaulin flap included in the price). Other materials at their individual cost

Material: tarpaulin
 Size (cm): W 36 x H 29 x D 10,5
 Decoration area (cm, digital print): on the flap W 35 x H 34
 Decoration possibilities: silkscreen print; embroidery; digital print; digitally printed label; metal emblem



bag body colour:

- black (1)
- white (18)
- silver (89)

1803909 MODUL 1 LORRYBAG®

main compartment with organizer features and mobile phone pouch. Choose your own flap! The flap is made in your preferred colour (tarpaulin flap included in the price). Other materials at their individual cost

Material: tarpaulin & tarpaulin
 Size (cm): W 37 x H 29 x D 13
 Decoration area (cm): tarpaulin: on the flap W 35,5 x H 38
 Decoration possibilities: silkscreen print; digital print; embroidery; digitally printed label; metal emblem



1803927 MODUL 1 CONFERENCE FOLDER

writing pad included; inside fabric and back: polyester 600d black; Choose your own design of cover! The cover is made in your preferred colour (tarpaulin included in the price) or other materials at their individual cost

Material: Polyester 600d & tarpaulin
 Size (cm): W 26 x H 34 x D 3
 Decoration area (cm, digital print): on the front W 22 x H 32
 Decoration possibilities: silkscreen print; embroidery; digital print; digitally printed label; metal emblem; doming



1809795 MODUL 1 CONFERENCE FOLDER

quality, functional writing case with large space for decoration; insert facility for A4 writing pad, A5 block; elastic support straps for pens, USB embroidery; etc.

Material: recycled PES felt
 Size (cm): W 26 x H 32 x D 1
 Packing (pcs): 50
 Decoration area (cm, embroidery): on the front W 20 x H 28
 Decoration possibilities: embroidery; transfer print; digitally printed label; woven label

CUSTOM-MADE:

WOULD YOU LIKE A LITTLE MORE?

ON YOUR BIKE



From notebook backpack to bike bag

"This notebook backpack is perfect – if only I could attach it to my bike..."
Great idea! We're always happy to make such special requests come true. For one customer, we converted the ACTIVE backpack into a bike bag. The hidden mounts cleverly give it an extra practical function.



padded cover flap for bike mounting hooks

padded shoulder straps

mounting hooks for bike racks



YOUR COLOUR? LOGO!



A bag in your corporate design.

“Could I get the bag in our shade of green?” Of course! On request, we also produce our bags in custom colours.



WHEN PRODUCTS TURN INTO BAGS



Using your own materials

“We’d love to turn our airbags into real bags.” We’re always happy when you suggest your own sewable materials – after all, they often become something truly special and unique, like these Air-BAGS.



ONE TEAM - A THOUSAND GREAT BAGS

DESIGN



CONSTRUCTION

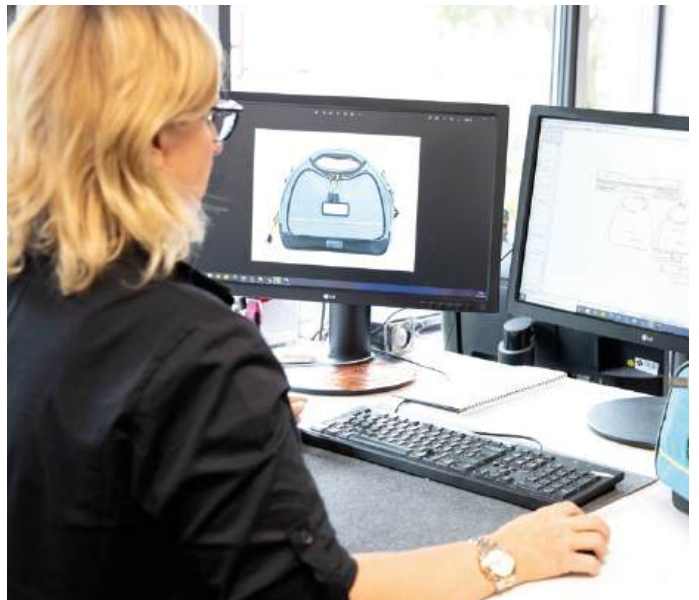

EMBROIDERY

SCREEN PRINTING

At our Bielefeld headquarters, everything revolves around bags. Here at HALFAR®, our experts work hand in hand. From the first sketch to the final stitch – everything happens under one roof. Whatever your wishes are, we'll bring them into bag form.

Original Bielefeld-Bags

Designing, constructing, cutting, sewing, printing, embroidering – in Bielefeld, we create designs and prototypes directly in-house.

CUTTING

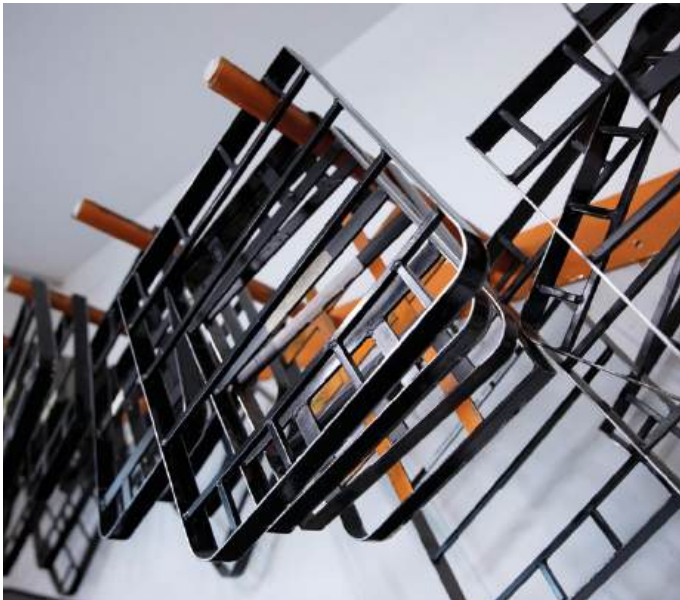

PROTOTYPE CONSTRUCTION



TRANSFER PRINTING

QC & LOGISTICS

ONE CLICK - EVERYTHING IN VIEW!

THE NEW ONLINE CONFIGURATOR



01

CHOOSE A COLOUR

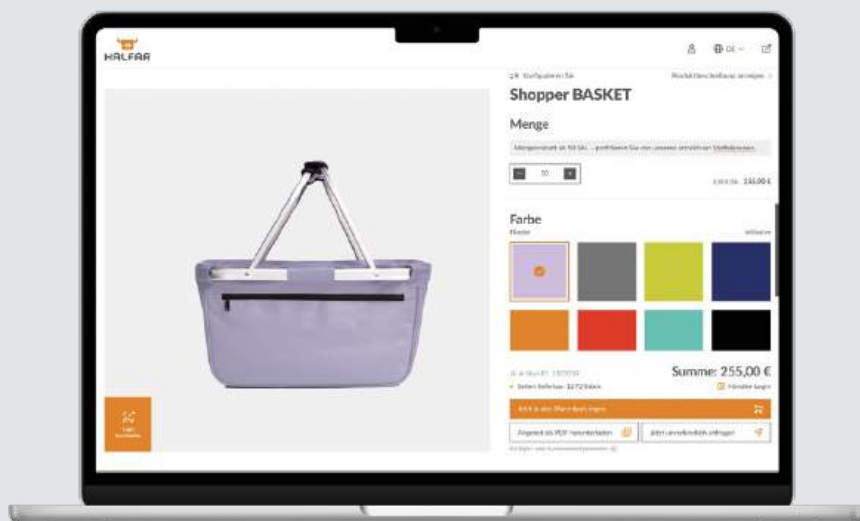

Have you already tried our new online configurator? You can place your logo on our bags, try out colours and designs, and calculate the price – all in one go.

Try it now:



Go directly to
the new
configurator!

02

UPLOAD YOUR LOGO



03

SELECT FINISHING



04

DONE





ONE LOGO, ONE PRICE:

What your favourite bag costs with your logo is now just a few clicks away. Whether for screen printing, embroidery or transfer printing – here you get one clear price for your chosen type of finishing – ALL-IN-ONE. Let's go!

SCREEN PRINTING

Direct printing process for intense colour application and durability.



EMBROIDERY

Very refined and particularly long-lasting. Available in many colours. Combines harmoniously with materials such as felt.



TRANSFER PRINT

Ideal for logos with many colours, precise motifs or gradients. Even bright neon, metallic and reflective colours are possible.



METAL EMBLEM

For a lasting impression. You can immortalize your logos on special quality metal emblems. Choose from two versions: either metal emblems with a stylishly UV printing, or metal emblems with doming. On these the logo looks vividly colourful and very sculptured and the metal works like a frame.

for UV printing

for Doming

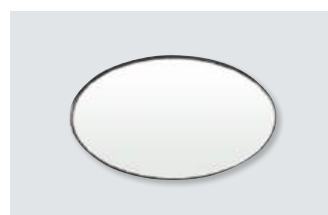
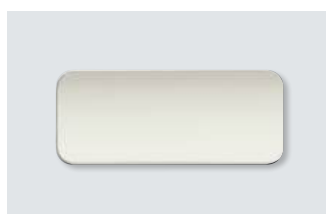
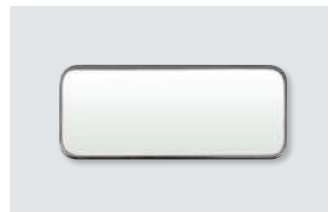

HALFAR FAST LANE®

The pioneering refinement of HALFAR®. Brilliant, pin-pointed printing in photo quality, with low energy consumption! Rapid drying, short production times! Long-lasting, elegant and one of a kind. Can be refined, in part, with spot varnish - refinement that inspires.



DIGITAL PRINTING

High-quality, individual prints applied directly to promotional bags. Especially suitable for photo motifs or designs with fine colour gradients. Coated with a protective varnish to prevent chipping and fading.



DIGITAL PRINT LABEL

If you want to realise particularly detailed designs, this is often only possible before sewing the bag. The digital print label, however, offers flexibility – it can also be applied afterwards.



ALL LOGO?

We currently provide more than 12 decoration techniques, most of which we implement directly here in Bielefeld, and we can tell you a great deal about every one of them. In case you should have a question, please contact us. We are happy to advise you which logo works particularly well on which material, using which technique.

- Graphic files in vectorised .eps or .ai format
- taking care that all text is fully vectorised
- Colour information for digital printing: CMYK
- Colour information for screen print: PMS
- Photographic or bitmap images files should be in actual size with a minimum resolution of 300 dpi

BAG INDEX



WAIST BAGS

1818058 **PURE**
waist bag



019

1813352 **STEP**
waist bag



020

1809793 **SOLUTION**
waist bag



020

1818022 **DAILY**
waist bag



021

LEISURE BACKPACKS AND DRAWSTRING BAGS

new



1818064 **BASIC**
backpack

023



1815024 **FLOW**
backpack

024



1813355 **SOLUTION**
backpack

025



1802722 **KIDS**
backpack

025



1802716 **SPORT**
taffeta backpack

026



1813051 **FLASH**
drawstring bag

027



1813060 **PAINT**
drawstring bag

027



1816079 **CARE**
drawstring bag

028



1813055 **JOIN**
drawstring bag

029



1814002 **JERSEY**
drawstring bag

030



1813349 **STEP**
drawstring bag

030



1815000 **DIAMOND**
backpack

031



1813057 **EARTH**
drawstring bag

032



1813052 **ORGANIC**
drawstring bag

032



1816063 **PLANET**
drawstring bag

033



1816505 **LIKE**
backpack

034



1813348 **BEACH**
backpack

035



1812204 **REFLEX**
drawstring bag

036



1812206 **REFLEX**
backpack

036



1818036 **FELLOW**
notebook
backpack

037



1816080 **TREND**
monostrap

038



1818061 **STAR**
laptop backpack

039



1818062 **STARS**
backpack

039



1819202 **METRO**
backpack

040



1818038 **EVENT**
multi bag

041



1813058 **URBAN**
notebook
backpack

042



1818056 **MODERNCLASSIC**
backpack

043



1818016 **DAILY**
laptop backpack

044



1818014 **DAILY**
notebook
backpack

 044



1818048 **FLEX**
notebook
backpack

 045



1819201 **MELLOW**
backpack

 046



1816089 **STAGE**
notebook
backpack

 046



1818059 **PURE**
laptop
backpack

 047



1815012 **LOFT**
notebook
backpack

 048



1812198 **FASHION**
notebook
backpack

 048



1803908 **KURIER ECONOMY**
backpack

 049



1816072 **COUNTRY**
backpack

 050



1816502 **COUNTRY**
notebook
backpack

 051



1816076 **CIRCLE**
laptop
backpack

 052



1816068 **LOOM**
backpack

 052



1816520 **LIFE**
notebook
backpack

 053



1818039 **REFLEX M**
laptop
backpack

 054



1818018 **REFLEX L**
notebook
backpack

 055



1818032 **CIRCLE L**
notebook
backpack

 055



new
1818057 **MOLLE**
notebook
backpack

 056



1814021 **STORM**
backpack

 057

BACKPACKS FOR BUSINESS



new
1816511 **KURIER**
notebook
backpack

 059



1816514 **EUROPE**
notebook
backpack

 060



1816510 **EUROPE**
notebook
roller
backpack

 060



1816517 **EUROPE**
laptop
backpack

 061



1818015 **ACTIVE**
travel
backpack

 062



1818034 **ACTIVE**
notebook
backpack

 063



1816086 **EXPERT**
notebook
backpack

 064



1819200 **ORBIT**
notebook
backpack

 065



1812203 **IMPULSE**
notebook
backpack

 066



1809998 **PREMIUM**
notebook
backpack

 066



new
1818069 **SOLID**
notebook
backpack

 067



1816052 **FRAME**
notebook
backpack

 068



1815008 **HASHTAG**
notebook
backpack

 069



1807798 **MISSION**
notebook
backpack

 070



1814008 **GIANT**
business
notebook
backpack

 071

SPORTS BACKPACKS AND ACCESSORIES



1818054 **EXPLORE** backpack

☐☐073



1818025 **OUTDOOR** backpack

☐☐074



1818026 **OUTDOOR** daypack

☐☐075



1809123 **TRAIL** backpack

☐☐076



1813062 **STEP M** backpack

☐☐077



1813063 **STEP L** backpack

☐☐077



1803310 **CITY** daypack

☐☐078



1815023 **TEAM** backpack

☐☐078



1800780 **Sport** backpack

☐☐079



1806694 **GALAXY** backpack

☐☐079



1812216 **MOVE** drink system

☐☐080



1816512 **REFLEX** rain cover

☐☐081



1809787 **SPLASH 2** drybag

☐☐082



1809786 **SPLASH** drybag

☐☐082



1812214 **SPLASH** backpack

☐☐083



1818027 **SAFE 6 L** drybag

☐☐084



1818028 **SAFE 1.4 L** drybag

☐☐084



new

1818053 **DRYBAG** zipper bag

☐☐085

BICYCLE BAGS



1818050 **SOFTBASKET** felt lunchbag

☐☐087



1818049 **SOFTBASKET** lunchbag

☐☐087



1818011 **CYCLE** bike bag

☐☐088



1818012 **CYCLE** bicycle handlebar bag

☐☐090



1818013 **CYCLE** bicycle frame bag

☐☐091



1818063 **ORBIT** bicycle backpack

☐☐093







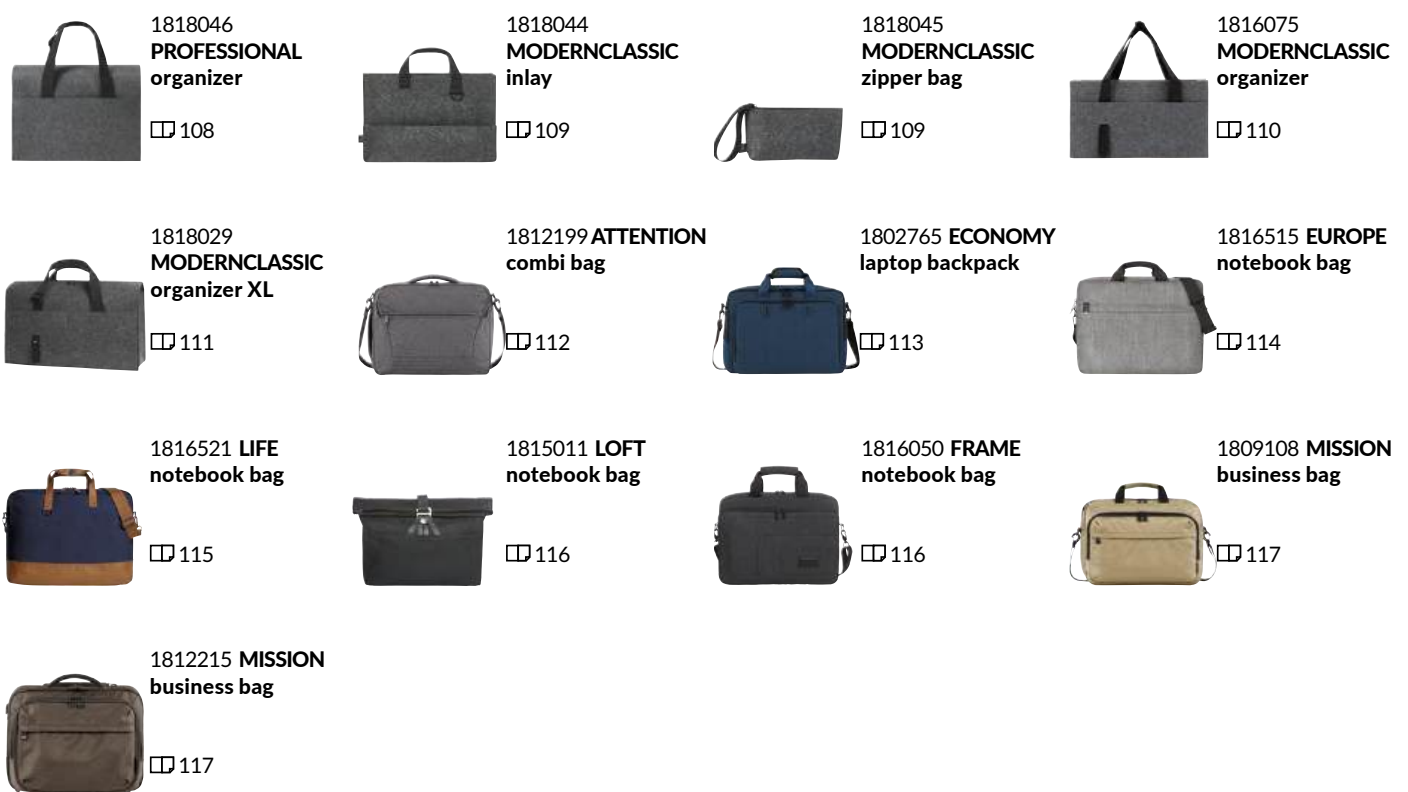







SHOULDER BAGS



















LAPTOP BAGS AND ORGANISERS



FOLDERS AND COVERS

 <p>1816522 LIFE sleeve 119</p>	 <p>1816053 FRAME sleeve 119</p>	 <p>1816082 MODERNCLASSIC laptop sleeve 120</p>	 <p>1809117 MODERNCLASSIC M sleeve 120</p>
 <p>1813056 ECONOMY M felt cover 121</p>	 <p>1809997 ECONOMY felt cover 121</p>	 <p>1802787 conference folder 122</p>	 <p>1813068 SCRIPT conference folder 122</p>
 <p>1815013 WORK conference folder 123</p>	 <p>1814034 ELEGANCE laptop bag 124</p>	 <p>1816056 FRAME organizer 124</p>	 <p>new 1818067 SHIFT laptop sleeve 125</p>
 <p>1814028 ELEGANCE zipper bag 126</p>	 <p>1814027 ELEGANCE case 126</p>		

SPORTS AND TRAVEL BAGS

 <p>1818033 DAILY weekender 128</p>	 <p>new 1818070 SOLID Sport/travelbag 129</p>	 <p>1818035 ACTIVE sport/travelbag 130</p>	 <p>1818037 OUTDOOR sports bag 131</p>
 <p>1813342 STEP sport/travelbag 132</p>	 <p>1807544 CANNY sports bag 133</p>	 <p>1814007 SOLUTION shoe bag 133</p>	 <p>1801676 SPORT sport/travelbag 134</p>
 <p>1815022 TEAM sport/travelbag 135</p>	 <p>1814006 CRAFT multi bag 136</p>	 <p>1814017 FASHION travel bag 136</p>	 <p>1816073 COUNTRY sport/travelbag 137</p>
 <p>1816518 EUROPE sport/travelbag 138</p>	 <p>1816069 LOOM sport/travelbag 139</p>	 <p>1815003 COMMUNITY travel bag 140</p>	 <p>1818060 PURE sport-/travelbag 141</p>

1816054 **FRAME**
sport/travelbag



 142

1809789 **MISSION**
sport/travelbag



 143



1815010 **HASHTAG**
roller bag

 144

1813347 **IMPULSE**
roller bag



 145

COSMETICS AND TOILET BAGS

1818051 **FLEX**
wash bag



 147

1818040 **ACTIVE**
wash bag



 148

1816500 **CIRCLE**
zipper bag



 149

1816055 **FRAME**
zipper bag



 150

1818021 **DAILY**
zipper bag



 150

1802719 **SPORT**
wash bag



 151

1801059 **BUSINESS**
wash bag



 151

1800177 **UNIVERSAL**
zipper bag



 152

1800772 **UNIVERSAL**
bag with press
buttons



 152

1813059 **SWITCH**
zipper bag



 153

1807546 **COLLECT**
zipper bag



 153

1814012 **ORGANIC M**
zipper bag



 154

1814011 **ORGANIC S**
zipper bag



 154

1815021 **ORGANIC**
case



 155

SHOPPING BAGS AND BASKETS



new 1818042 **ORGANIC**
casual shopper

 157



1816507 **SUNNY**
Shopper

 158



new 1818066 **ORGANIC**
wellness shopper
baG

 159



1814023 **BEACH**
Shopper

 160



1814003 **NATIVE**
Shopper

 161



1815020 **FAIR**
Shopper

 162



new 1818041 **ORGANIC**
drawstring tote
bag

 163



1815021 **ORGANIC**
case

 164



1816061 **ORGANIC**
reusable produce
bag

 164



1809799 **ORGANIC**
Shopper

 165



1815014 **EARTH**
Shopper

 166



1809798 **MALL**
Shopper

 167



1816062 **PLANET Shopper**

☐☐ 168



1816065 **PLANET tote bag**

☐☐ 169



1807785 **BONNY Shopper**

☐☐ 170



1807781 **SOLUTION Shopper**

☐☐ 170



1814016 **STORE Shopper**

☐☐ 171



1816070 **LOOM Shopper**

☐☐ 172



1816519 **LIFE Shopper**

☐☐ 173



1815017 **SKY Shopper**

☐☐ 174



1818023 **BIG Shopper**

☐☐ 175



1816078 **CIRCLE Shopper**

☐☐ 176



1818019 **DAILY shopper**

☐☐ 177



1814000 **JERSEY Shopper**

☐☐ 178



1807556 **MODERNCLASSIC city shopper**

☐☐ 178



1805710 **NEWCLASSIC Shopper**

☐☐ 179



1818031 **SOFTBASKET felt shopper**

☐☐ 179



1818055 **MONO Shopper**

☐☐ 181



1818020 **SOFTBASKET Shopper**

☐☐ 183



1807777 **BLACKBASKET Shopper**

☐☐ 185



1808800 **BASKET Shopper**

☐☐ 185



1803939 **BASKET Shopper**

☐☐ 186

1818024 **BASKET inlay**



☐☐ 187

COOLER BAGS



1818049 **SOFTBASKET lunchbag**

☐☐ 189



1818050 **SOFTBASKET felt lunchbag**

☐☐ 190



1816503 **TREND cooler backpack**

☐☐ 191



1802721 **SPORT cool bag**

☐☐ 192



1815028 **FLOW thermo bag**

☐☐ 193



1814015 **SOLUTION lunchbag**

☐☐ 194



1809797 **SOLUTION cool bag**

☐☐ 195



1818052 **BOTTLE thermo bag**

☐☐ 197



1818017 **DAILY cooler shopper**

☐☐ 198



1815015 **BASKET cooler shopper**

☐☐ 199



1818030 **SOFTBASKET cooler shopper**

☐☐ 200



1812211 **FAMILY XL cool bag**

☐☐ 201

HALFAR® MODULAR SYSTEM



1109109 ORIGINAL 2
LorryBag®
notebook
☐☐ 208



1101401 ORIGINAL 1
LorryBag®
☐☐ 208



1101401#H ORIGINAL 1
LorryBag®
☐☐ 208



1101401#M ORIGINAL 1
LorryBag®
☐☐ 208



1101401#S ORIGINAL 1
LorryBag®
☐☐ 208



1809110 MODUL 2
LorryBag®
notebook
☐☐ 209



1803909 MODUL 1
LorryBag®
☐☐ 209



1809795 MODUL 1
conference folder
☐☐ 209



1803927 MODUL 1
conference folder
☐☐ 209























articles

1800177	zipper bag UNIVERSAL	152	1814017	travel bag FASHION	136	1818020	shopper SOFTBASKET	183
1800772	bag with press buttons UNIVERSAL	152	1814021	backpack STORM	57	1818021	zip bag DAILY	150
1800780	backpack SPORT	79	1814023	shopper BEACH	160	1818022	waist bag DAILY	21
1801059	wash bag BUSINESS	151	1814026	CrossBag ELEGANCE	99	1818023	shopper BIG	175
1801676	sport/travel bag SPORT	134	1814027	case ELEGANCE	126	1818024	inlay BASKET	187
1802716	taffeta backpack SPORT	26	1814028	zipper bag ELEGANCE	126	1818025	backpack OUTDOOR	74
1802719	wash bag SPORT	151	1814034	laptop bag ELEGANCE	124	1818026	daypack OUTDOOR	75
1802721	cool bag SPORT	192	1815000	backpack DIAMOND	31	1818027	drybag SAFE 6 L	84
1802722	backpack KIDS	25	1815003	travel bag COMMUNITY	140	1818028	drybag SAFE 1,4 L	84
1802765	laptop backpack ECONOMY	113	1815008	notebook backpack HASHTAG	69	1818029	organizer XL ModernClassic	111
1802787	conference folder	122	1815010	roller bag HASHTAG	144	1818030	cooler shopper SOFTBASKET	200
1802814	LorryBag® ECONOMY	96	1815011	notebook bag LOFT	116	1818031	felt shopper SOFTBASKET	179
1803310	daypack CITY	78	1815012	notebook backpack LOFT	48	1818032	notebook backpack CIRCLE L	55
1803908	backpack KURIER ECONOMY	49	1815013	conference folder WORK	123	1818033	weekender DAILY	128
1803939	shopper BASKET	186	1815014	shopper EARTH	166	1818034	notebook backpack ACTIVE	63
1805710	shopper NewClassic	179	1815015	cooler shopper BASKET	199	1818035	sport/travel bag ACTIVE	130
1806052	shoulder bag STYLE	97	1815017	shopper SKY	174	1818036	notebook backpack FELLOW	37
1806694	backpack GALAXY	79	1815020	shopper FAIR	162	1818037	sports bag OUTDOOR	131
1807544	sports bag CANNY	133	1815021	case ORGANIC	155/164	1818038	multi bag EVENT	41/103
1807546	zipper bag COLLECT	153	1815022	sports bag TEAM	135	1818039	laptop backpack REFLEX M	54
1807554	courier bag ModernClassic	105	1815023	backpack TEAM	78	1818040	wash bag ACTIVE	148
1807556	city shopper ModernClassic	178	1815024	backpack FLOW	24	1818041	drawstring tote bag ORGANIC	163
1807777	shopper BLACKBASKET	185	1815028	thermo bag FLOW	193	1818042	casual shopper ORGANIC	157
1807781	shopper SOLUTION	170	1815029	CrossBag FLOW	98	1818043	notebook bag ACTIVE	95
1807785	shopper BONNY	170	1816050	notebook bag FRAME	116	1818044	inlay ModernClassic	109
1807798	notebook backpack MISSION	70	1816051	notebook shopper FRAME	100	1818045	zipper bag ModernClassic	109
1808800	felt shopper BASKET	185	1816052	notebook backpack FRAME	68	1818046	organizer PROFESSIONAL	108
1809108	business bag MISSION	117	1816053	sleeve FRAME	119	1818048	notebook backpack FLEX	45
1809117	sleeve ModernClassic M	120	1816054	sport/travel bag FRAME	142	1818049	lunchbag SOFTBASKET	87/189
1809123	backpack TRAIL	76	1816055	zip bag FRAME	150	1818050	felt lunchbag SOFTBASKET	87/190
1809786	drybag SPLASH	82	1816056	organizer FRAME	124	1818051	wash bag FLEX	147
1809787	drybag SPLASH 2	82	1816057	CrossBag FRAME	99	1818052	thermo bag BOTTLE	197
1809789	sport/travel bag MISSION	143	1816061	reusable produce bag ORGANIC	164	1818053	zipper bag DRYBAG	85
1809793	waist bag SOLUTION	20	1816062	shopper PLANET	168	1818054	backpack EXPLORE	73
1809797	cool bag SOLUTION	195	1816063	drawstring bag PLANET	33	1818055	shopper MONO	181
1809798	shopper MALL	167	1816065	tote bag PLANET	169	1818056	backpack ModernClassic	43
1809799	shopper ORGANIC	165	1816066	shoulder bag LOOM	100	1818057	notebook backpack MOLLE	56
1809997	felt cover ECONOMY	121	1816067	multi bag LOOM	101	1818058	waist bag PURE	19
1809998	notebook backpack PREMIUM	66	1816068	backpack LOOM	52	1818059	laptop backpack PURE	47
1812198	notebook backpack FASHION	48	1816069	sport/travel bag LOOM	139	1818060	sport/travel bag PURE	141
1812199	combi bag ATTENTION	112	1816070	shopper LOOM	172	1818061	laptop backpack STAR	39
1812203	notebook backpack IMPULSE	66	1816071	shoulder bag COUNTRY	104	1818062	backpack STAR S	39
1812204	drawstring bag REFLEX	36	1816072	backpack COUNTRY	50	1818063	bike backpack ORBIT	93
1812205	shoulder bag REFLEX	102	1816073	sport/travel bag COUNTRY	137	1818064	backpack BASIC	23
1812206	backpack REFLEX	36	1816075	organizer ModernClassic	110	1818066	wellness shopper bag ORGANIC	159
1812211	cool bag FAMILY XL	201	1816076	laptop backpack CIRCLE	52	1818067	laptop sleeve SHIFT	125
1812214	backpack SPLASH	83	1816077	shoulder bag CIRCLE	106	1818069	notebook backpack SOLID	67
1812215	business trolley MISSION	117	1816078	shopper CIRCLE	176	1818070	sport/travel bag SOLID	129
1812216	drink system MOVE	80	1816079	drawstring bag CARE	28	1819200	notebook backpack ORBIT	65
1812220	shoulder bag KURIER	102	1816080	monostrap TREND	38	1819201	backpack MELLOW	46
1813051	drawstring bag FLASH	27	1816082	laptop sleeve ModernClassic	120	1819202	backpack METRO	40
1813052	drawstring bag ORGANIC	32	1816086	notebook backpack EXPERT	64			
1813055	drawstring bag JOIN	29	1816089	notebook backpack STAGE	46			
1813056	felt cover ECONOMY M	121	1816500	zipper bag CIRCLE	149			
1813057	drawstring bag EARTH	32	1816502	notebook backpack COUNTRY	51			
1813058	notebook backpack URBAN	42	1816503	cooler backpack TREND	191			
1813059	zipper bag SWITCH	153	1816505	backpack LIKE	34			
1813060	drawstring bag PAINT	27	1816507	shopper SUNNY	158			
1813062	backpack STEP M	77	1816510	notebook roller backpack EUROPE	60			
1813063	backpack STEP L	77	1816511	notebook backpack KURIER	59			
1813066	shoulder bag ModernClassic	105	1816512	rain cover REFLEX	81			
1813068	conference folder SCRIPT	122	1816514	notebook backpack EUROPE	60			
1813342	sport/travel bag STEP	132	1816515	notebook bag EUROPE	114			
1813347	roller bag IMPULSE	145	1816517	laptop backpack EUROPE	61			
1813348	backpack BEACH	35	1816518	sport/travel bag EUROPE	138			
1813349	drawstring bag STEP	30	1816519	shopper LIFE	173			
1813352	waist bag STEP	20	1816520	notebook backpack LIFE	53			
1813355	backpack SOLUTION	25	1816521	notebook bag LIFE	115			
1814000	shopper JERSEY	178	1816522	sleeve LIFE	119			
1814002	drawstring bag JERSEY	30	1818011	bike bag CYCLE	88			
1814003	shopper NATIVE	161	1818012	bicycle handlebar bag CYCLE	90			
1814006	multi bag CRAFT	136	1818013	bicycle frame bag CYCLE	91			
1814007	shoe bag SOLUTION	133	1818014	laptop backpack DAILY	44			
1814008	business notebook backpack GIANT	71	1818015	travel backpack ACTIVE	62			
1814011	zipper bag ORGANIC S	154	1818016	notebook backpack DAILY	44			
1814012	zipper bag ORGANIC M	154	1818017	cooler shopper DAILY	198			
1814015	lunchbag SOLUTION	194	1818018	notebook backpack REFLEX L	55			
1814016	shopper STORE	171	1818019	shopper DAILY	177			

colours

1	black
2	light grey
3	navy
4	yellow
5	red
6	transparent
8	royal blue
10	anthracite
11	orange
18	white
19	jade green
22	beige
26	wine red
32	neon yellow
34	neon orange
44	dark green
54	grey
55	green
56	olive
60	black-black
72	magenta
89	silver
95	colorful
115	medium grey
145	light grey
155	blue
169	orange
170	light blue
171	green
172	pink
187	apple green
197	dark red
198	beige
215	red
220	taupe
222	off-white
223	green
225	ice blue
272	caramel
306	light green
307	fuchsia
308	navy-brown
309	grey-brown
310	coyote brown
336	black matt
450	dusky pink
455	pigeon blue
638	grey sprinkle
643	mint
644	green-grey
645	copper
652	cyan
678	black sprinkle
691	teal
704	nature
716	blue sprinkle
717	green sprinkle
722	blue-grey sprinkle
723	night grey
724	red-yellow
726	navy-red
727	apple green- green
728	light-grey sprinkle
735	brown
739	khaki
740	black-grey sprinkle
742	mustard yellow
745	dark burgundy
746	red sprinkle
789	lilac

icons

	notebook bag fits most
	fits most tablets
	headphone opening
	food grade
	backpack carry function
	temperature retentive
	splash-water resistant
	FAST LANE
	cotton
	organic cotton
	jute + cotton
	poly cotton
	recycled material
	PVC free
	serial
	shoe compartment
	foldable
	RFID protect
	anti-theft functions
	organizer
	AIR TAG
	IATA
	lightweight

